



GAMME

# Gold

PERSONNALISEZ VOTRE CANAPÉ  
AU FIL DE VOS ENVIES

- JANVIER 2025 -

HOME SPIRIT

FRANCE





# HOME SPIRIT

FRANCE

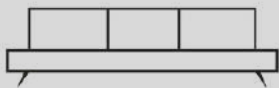

Fabricant Français de canapé dans les Hauts de France depuis 1965

#MEUBLEZ VOUS FRANÇAIS

17 rue des forts  
59960 Neuville-en-Ferrain  
France

contact@homespirit.fr  
03 28 33 07 28  
www.homespirit.fr

## FABRICANT FRANÇAIS ENGAGÉ !

Située au coeur de la région Lilloise, Home Spirit est une entreprise familiale **créée en 1965**. Fidèle à notre démarche "Fabrication française", **80% de nos fournitures sont achetées à moins de 100km**.

## OSEZ L'ÉCO-QUALITÉ !

Home Spirit s'engage pour une conception et une réalisation éco-responsable.



bois issus de forêts gérées  
durablement



matériaux de fabrication  
recyclés et recyclables

## CRÉÉ POUR ET AVEC VOUS !

Notre Atelier de Design vous propose des **produits uniques** grâce aux multiples possibilités de **personnalisation**.



# HOME SPIRIT

FRANCE

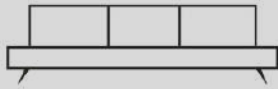

French sofa manufacturer from 1965

#MEUBLEZ VOUS FRANÇAIS

17 rue des forts  
59960 Neuville-en-Ferrain  
France

contact@homespirit.fr  
+33 (0) 3 28 33 98 26  
www.homespirit.fr

## FRENCH MANUFACTURER COMMITTED !

Located in the heart of Europe, Home Spirit is a family-run business **created in 1965**. Faithful to our "French Manufacturing" approach, **80% of our supplies are purchased less than 100km away**.

## DARE THE ECO-QUALITY !

Home Spirit is committed to eco-responsible design and production.

  
Wood from sustainable forests

  
Recycled and recyclable manufacturing materials

## CREATE FOR AND WITH YOU !

Our Design Workshop offers you **unique products** thanks to the multiple possibilities of **customization**.





# FORMULE FLASH

4 modèles / models  
8 tailles / sizes  
2 tissus / fabrics

Fabrication sous 1 semaine  
Manufactured in 1 week

## BIARRITZ



3 pl / seats

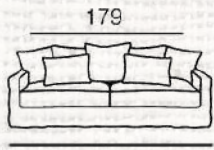

179

206

4 pl / seats

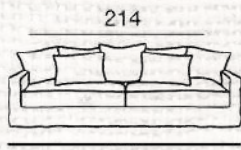

214

240

## BISCARROSSE



3 pl / seats

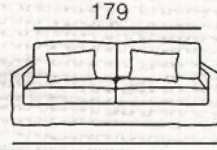

179

206

4 pl / seats

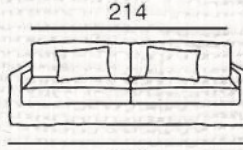

214

240

## CAP FERRET



4 pl / seats

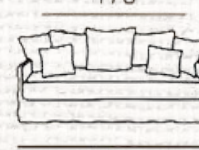

173

185

5 pl / seats

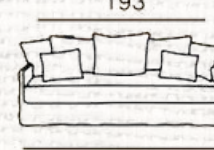

193

205

## BIDART



3 pl / seats

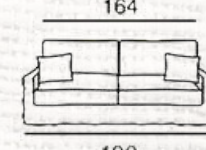

164

190

Mat. 140 cm

4 pl / seats

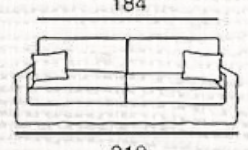

184

210

Mat. 160 cm

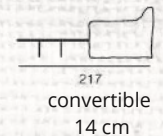

217  
convertible  
14 cm

CHOIX DU TISSU  
FABRIC SELECTION



SWEET  
ECRU

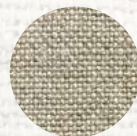

NEWLIN  
NATUREL

HOME SPIRIT

FRANCE

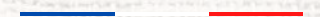
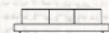



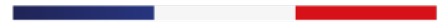

MADE IN FRANCE

# 1965

Accueillant & Rétro



**HOME SPIRIT**

FRANCE

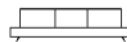

# 1965

## Accueillant & Rétro

MADE IN FRANCE

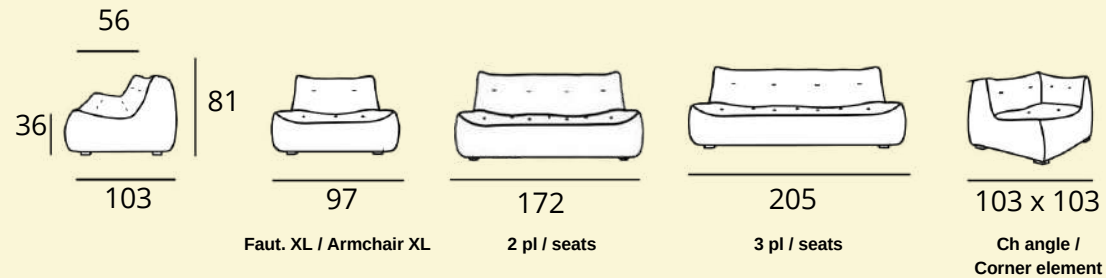

**Structure :** Mousse HR 35 kg/m<sup>3</sup>, mousse polyéther 17 kg/m<sup>3</sup> + HR 26 kg/m<sup>3</sup>, posé sur un panneau de bois. **Pieds :** Bois. **Finition :** Tapissier.

**Frame:** HR foam 35 kg/m<sup>3</sup>, HR foam 35 kg/m<sup>3</sup> + polyether foam 17 kg/m<sup>3</sup> + HR 26 kg/m<sup>3</sup>, on a wooden panel. **Legs:** Wood. **Finish:** Fixed cover.

HOME SPIRIT

FRANCE



homespirit.fr

MADE IN FRANCE

# ALBI

Aisance & Volume



HOME SPIRIT

FRANCE

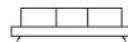

# ALBI

## Aisance & Volume

MADE IN FRANCE

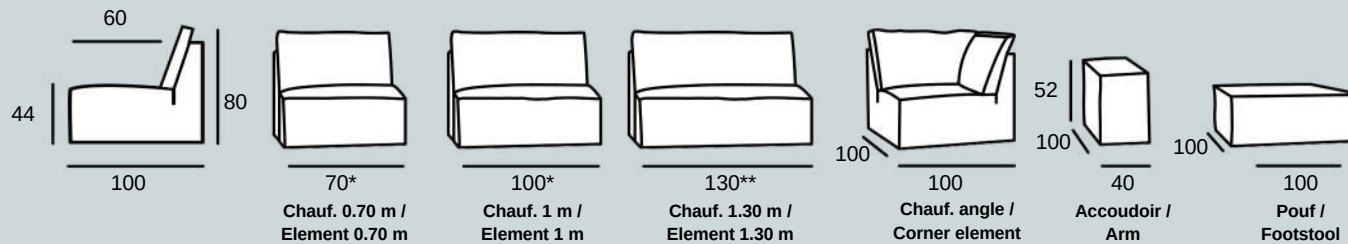

**Option :** largeur sur mesure : \* de 70 à 100 cm. \*\* de 100 à 130 cm.

**Option:** custom made elements: \* from 70 to 100 cm. \*\* from 100 to 130 cm.

**Structure :** Hêtre, panneaux multiplex et panneaux de fibres. Structure enrobée de mousse polyuréthane. Manchette enrobée de ouate 650 g. Suspension ressorts Nosags. **Assise :** HR 35 kg/m<sup>3</sup> + HR 25 kg/m<sup>3</sup> + ouate. **Dossier :** remplissage plumes/flocons. **Couture :** Bord à bord, pincé. **Pieds :** Plastique. **Finition :** tapissier, non convertible.

**Frame:** Solid beech wood, multiplex panels and fiber panels . Frame wrapped in foam cover and double layered with a fiber cover. Suspension Nosags springs. **Seat cushions:** HR foam 35 kg/m<sup>3</sup> + HR foam 25 kg/m<sup>3</sup> + cotton-wool. **Back cushions:** Feathers/foam flakes. **Sewing:** Pinched sewing. **Legs:** Plastic. **Finish:** Fixed covers.

HOME SPIRIT

FRANCE



homespirit.fr



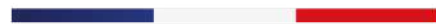

MADE IN FRANCE

# ARLES

Aisance & Volume



**HOME SPIRIT**

FRANCE

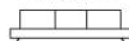

# ARLES

## Aisance & Volume

MADE IN FRANCE

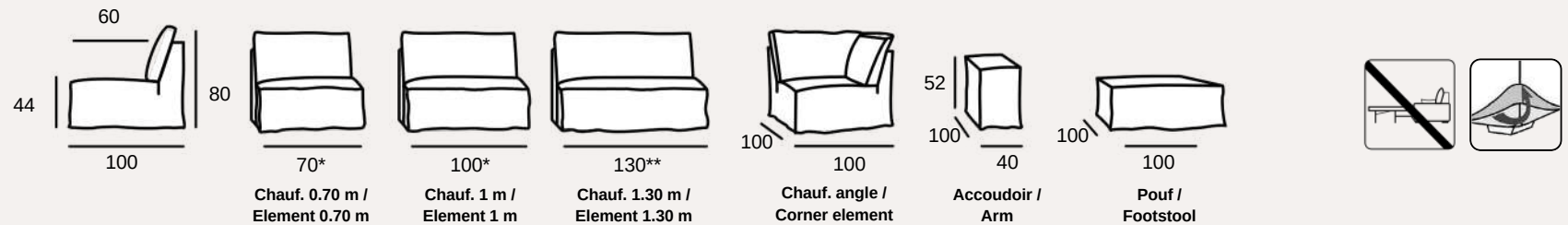

**Option :** largeur sur mesure : \* de 70 à 100 cm. \*\* de 100 à 130 cm.

**Option:** custom made elements: \* from 70 to 100 cm. \*\* from 100 to 130 cm.

**Structure :** Hêtre, panneaux multiplex et panneaux de fibres. Structure enrobée de mousse polyuréthane. Manchette enrobée de ouate 650 g. Suspension ressorts Nosags. **Assise :** HR 35 kg/m<sup>3</sup> + HR 25 kg/m<sup>3</sup> + ouate. **Dossier :** remplissage plumes/flocons. **Couture :** Surpiqûre plate. **Pieds :** Plastique. **Finition :** 100% déhoussable, non convertible.

**Frame:** Solid beech wood, multiplex panels and fiber panels . Frame wrapped in foam cover and double layered with a fiber cover. Suspension Nosags springs. **Seat cushions:** HR foam 35 kg/m<sup>3</sup> + HR foam 25 kg/m<sup>3</sup> + cotton-wool. **Back cushions:** Feathers/foam flakes. **Sewing:** Flat topstitching. **Legs:** Plastic. **Finish:** Removable covers.

HOME SPIRIT

FRANCE



homespirit.fr



MADE IN FRANCE

# AUSTIN

Caractère & Éléance



**HOME SPIRIT**

FRANCE

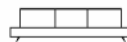

# AUSTIN

## Caractère & Éléance

MADE IN FRANCE

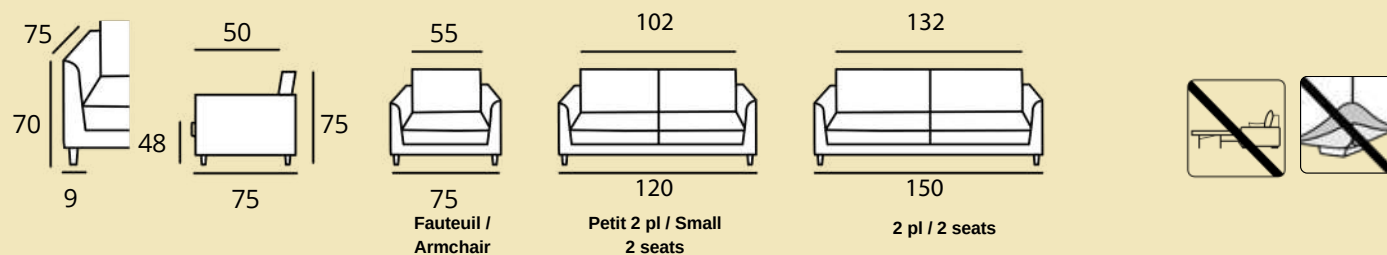

**Structure** : Hêtre, panneaux multiplex et panneaux de fibres. Structure enrobée de mousse polyuréthane et d'une sous-housse en foamé agrafée, suspension sangles. **Assise** : Mousse HR 35 kg/m<sup>3</sup> + HR 23 kg/m<sup>3</sup>. **Dossier** : Remplissage fibres creuses siliconées. **Pieds** : Bois wengé. **Finition** : Tapissier.

**Frame**: Beech wood, multiplex and fiber panels. Frame wrapped in foam cover. Suspension elastic bands. **Seat cushions**: HR foam 35 kg/m<sup>3</sup> + HR foam 23 kg/m<sup>3</sup>. **Back cushions**: fibers. **Legs** : Wooden in wenge color. **Finish**: Fixed covers.

HOME SPIRIT

FRANCE



homespirit.fr



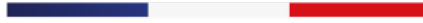

MADE IN FRANCE

# BANDOL

Confort & Naturel



HOME SPIRIT

FRANCE



# BANDOL

## Confort & Naturel

MADE IN FRANCE

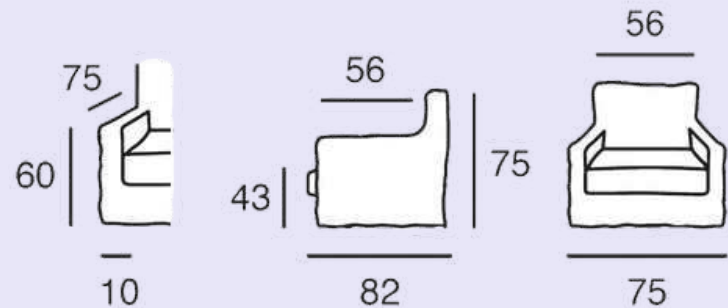

Fauteuil / Armchair



\* Option : pivotant / swivel



**Structure** : Hêtre, panneaux multiplex et panneaux de fibres. Structure enrobée de mousse polyuréthane et d'une sous-housse en foamé agrafée, suspension ressorts Nosags. **Assise** : Plumtex HR 35 kg/m<sup>3</sup> + percale remplissage plumes. **Pieds** : Bois. **Finition** : Déhoussable.  
\*Option : Fauteuil pivotant

**Frame:** Beech wood, multiplex and fiber panels. Frame wrapped in foam cover. Suspension Nosag springs.  
**Seat cushions:** Plumtex HR foam 35 kg/m<sup>3</sup> + layer of feathers. **Legs:** Wooden. **Finish:** Removable covers.  
\*Option : Swivel armchair



homespirit.fr



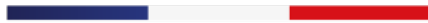

MADE IN FRANCE

# BIARRITZ & BONDUES

Charme & Naturel



HOME SPIRIT

FRANCE



# BIARRITZ & BONDUES

## Charme & Naturel

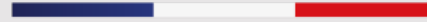

MADE IN FRANCE

### BIARRITZ Profondeur 100 cm

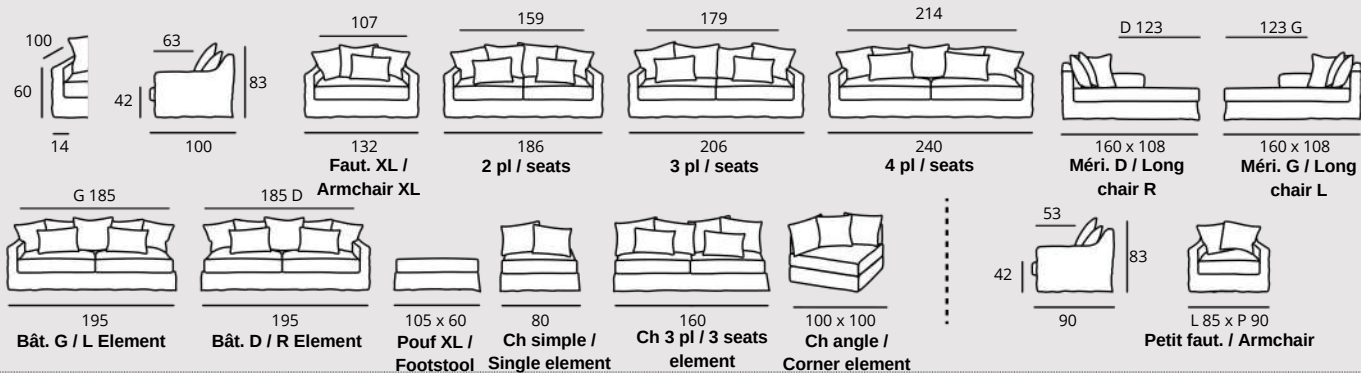

360°  
\* Option : petit  
fauteuil pivotant /  
swivel armchair

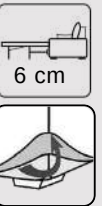

### BONDUES Profondeur 90 cm

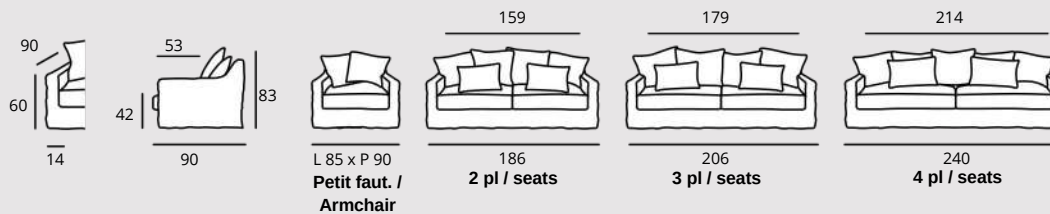

**Structure** : Hêtre, panneaux multiplex et panneaux de fibres. Structure enrobée de mousse polyuréthane et d'une sous-housse en foamé agrafée, suspension ressorts Nosags. **Assise** : Plumtex HR 35 kg/m<sup>3</sup> + percale remplissage plumes. **Dossier** : Coussins 60x60 cm, remplissage plumes/flocons. **Coussins de déco** : Remplissage plumes/flocons, 60x45 cm. **Pieds** : Bois. **Finition** : Déhoussable. \*Option : Petit fauteuil pivotant

**Frame**: Beech wood, multiplex and fiber panels. Frame wrapped in foam cover. Suspension no-sag springs. **Seat cushions**: Plumtex HR foam 35 kg/m<sup>3</sup> + layer of feathers. **Back cushions**: cushions 60x60 cm, feathers/foam flakes. **Deco cushions**: cushions 60x45 cm, feathers/foam flakes. **Legs**: Wooden. **Finish**: Removable covers. \*Option : Swivel armchair

**Nb de coussins (cushions number)** : Dos/Déco (back/deco) = Fauteuil : 1/1 - Faut XL : 3/1 - 2 pl : 4/2 - 3 pl : 4/2 - 4 pl : 5/2 - Méridienne : 2/1 - Bâtard : 5/2 - Ch simple : 2/0 - Ch double : 4/2 - Ch angle : 3/0.



homespirit.fr

MADE IN FRANCE

# BISCARROSSE & BRUGES

Charme & Naturel



HOME SPIRIT

FRANCE





# BISCARROSSE & BRUGES

Charme & Naturel

MADE IN FRANCE

## BISCARROSSE

Profondeur 100 cm

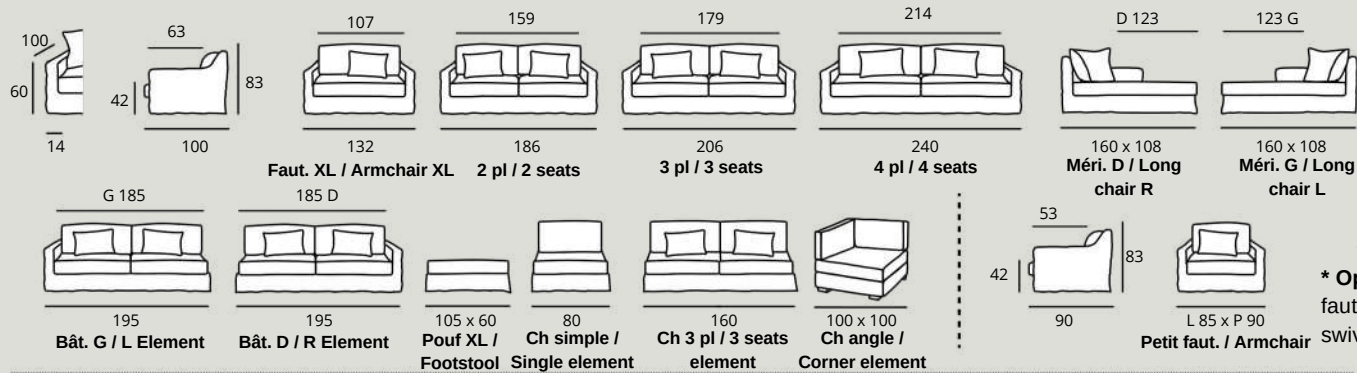

## BRUGES

Profondeur 90 cm

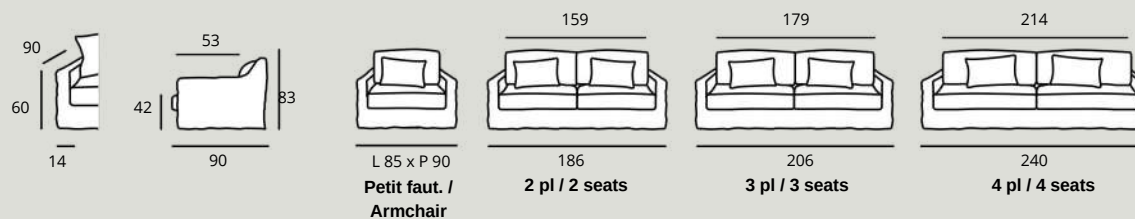

**Structure** : Hêtre, panneaux multiplex et panneaux de fibres. Structure enrobée de mousse polyuréthane et d'une sous-housse en foamé agrafée, suspension ressorts Nosags. **Assise** : Plumtex HR 35 kg/m<sup>3</sup> + percale remplissage plumes. **Dossier** : Coussins rectangulaires, remplissage plumes/flocons. **Coussins de déco** : Remplissage plumes/flocons, 60x45 cm. **Pieds** : Bois. **Finition** : Déhoussable. **\*Option** : Petit fauteuil pivotant

**Frame**: Beech wood, multiplex and fiber panels. Frame wrapped in foam cover. Suspension no-sag springs. **Seat cushions**: Plumtex HR foam 35 kg/m<sup>3</sup> + layer of feathers. **Back cushions**: rectangular cushions, feathers/foam flakes. **Deco cushions**: cushions 60x45 cm, feathers/foam flakes. **Legs**: Wooden. **Finish**: Removable covers. **\*Option** : Swivel armchair

HOME SPIRIT

FRANCE



homespirit.fr

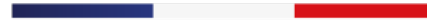

MADE IN FRANCE

# BLAGNAC

Élégant & Intemporel



HOME SPIRIT

FRANCE

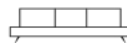

# BLAGNAC

## Élégant & Intemporel

MADE IN FRANCE

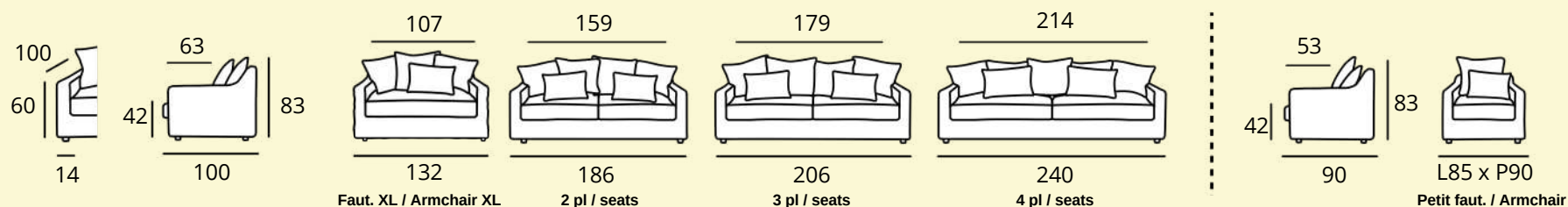

**Structure** : Hêtre, panneaux multiplex et panneaux de fibres. Structure enrobée de mousse polyuréthane et d'une sous-housse en foamé agrafée, suspension ressorts Nosags. **Assise** : Plumtex HR 35 kg/m<sup>3</sup> + percale remplissage plumes. **Dossier** : Coussins 60 x 60 cm, remplissage plumes/flocons. **Coussins déco** : Coussins 60 x 45 cm, remplissage plumes/flocons. **Pieds** : Bois, teinté wengé. **Finition** : Tapissier.

**Frame**: Beech wood, multiplex and fiber panels. Frame wrapped in foam cover. Suspension no-sag springs. **Seat cushions**: Plumtex HR foam 35 kg/m<sup>3</sup> + layer of feathers. **Back cushions**: cushions 60x60 cm, feathers/foam flake. **Deco cushions**: cushions 60x45 cm, feathers/foam flake. **Legs**: Wooden, wengé. **Finish**: Fixed covers.

**Nb de coussins (cushions number)** : Dos/Déco (back/deco) = Fauteuil : 1/1 - 2 pl : 4/2 - 3 pl : 4/2 - 4 pl : 5/2.



homespirit.fr



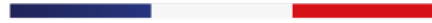

MADE IN FRANCE

# BEAUSSET

Élégant & Intemporel



HOME SPIRIT

FRANCE

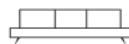

# BEAUSSET

## Élégant & Intemporel

MADE IN FRANCE

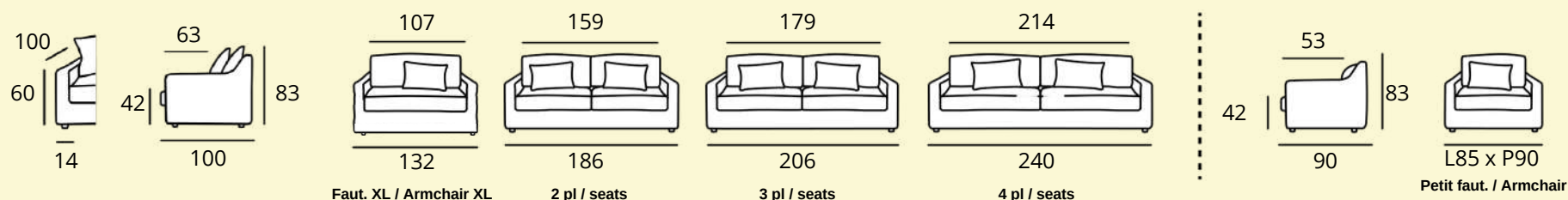

**Structure :** Hêtre, panneaux multiplex et panneaux de fibres. Structure enrobée de mousse polyuréthane et d'une sous-housse en foamé agrafée, suspension ressorts Nosags. **Assise :** Plumtex HR 35 kg/m<sup>3</sup> + percale remplissage plumes. **Dossier :** coussins rectangulaires, remplissage plumes/flocons. **Coussins déco :** Coussins 60 x 45 cm, remplissage plumes/flocons. **Pieds :** Bois, teinté wengé. **Finition :** Tapissier.

**Frame:** Beech wood, multiplex and fiber panels. Frame wrapped in foam cover. Suspension no-sag springs. **Seat cushions:** Plumtex HR foam 35 kg/m<sup>3</sup> + layer of feathers. **Back cushions:** rectangular cushions, feathers/foam flake. **Deco cushions:** cushions 60x45 cm, feathers/foam flake. **Legs:** Wooden, wengé. **Finish:** Fixed covers.

HOME SPIRIT

FRANCE



homespirit.fr

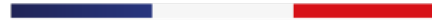

MADE IN FRANCE

# BIDART

Convertible Grand Confort 14cm



**HOME SPIRIT**

FRANCE

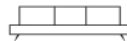



# BIDART

## Convertible Grand Confort 14cm

MADE IN FRANCE

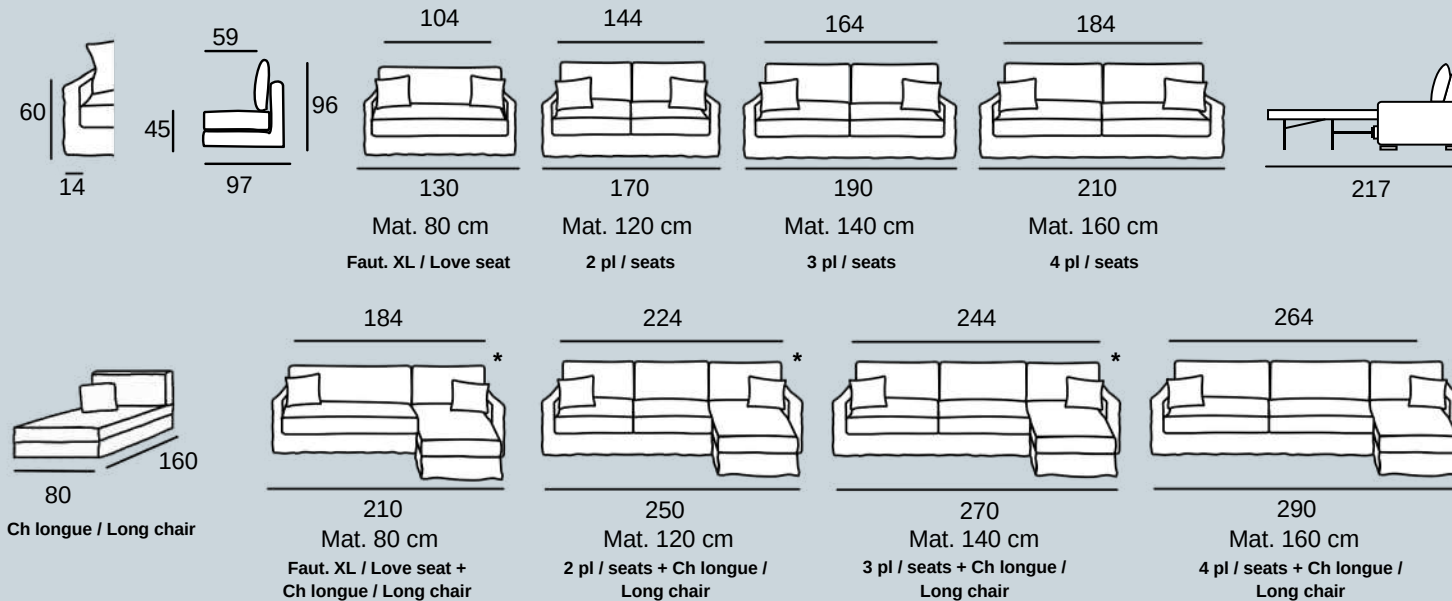

\*Angle réversible à gauche ou à droite

\*Corner réversible R/L

**Structure** : Hêtre, panneaux multiplex et panneaux de fibres. Mécanique autoporteuse sommier grille et sangles entrecroisées en pieds ou mécanique autoporteuse Black Edition sommier latte (bi-zone pour 3 et 4 places) et sangles entrecroisées en pieds. **Assise** : Plumtex HR 35 kg/m<sup>3</sup> + percale remplissage plumes. **Dossier** : remplissage plumes/flocons. **Coussins de déco** : Coussins 60 x 45 cm, remplissage plumes/flocons. **Finition** Déhoussable. **Pieds** : Bois. **Matelas** : 14 cm Mousse HR Optimum 35 kg/ m<sup>3</sup>. Dimensions : 80-120-140-160 x 200 cm. Assises et dossiers restent en place à l'ouverture de la mécanique.

**Frame**: Solid beech wood, multiplex panels and fiber panels. **Selfsupporting bed mechanism** : Grid and elastic bands or selfsupporting bed mechanism Black Edition : slatted (bi-zone for 3 and 4 seats) and elastic bands. **Seat cushions**: Plumtex HR 35 kg/m<sup>3</sup> + layer of feathers. **Back cushions**: filled with feathers/foam flakes. **Deco cushions**: cushions 60 x 45 cm, feathers/foam flakes. **Finish**: Removable covers. **Legs**: Wooden. **Mattress**: 14 cm thick, HR foam Optimum 35 kg/m<sup>3</sup>. Dimensions 80-120-140-160 x 200 cm. No need to remove back and seat cushions when folding and unfolding.

HOME SPIRIT

FRANCE



homespirit.fr



MADE IN FRANCE

# CAP FERRET

& SAINT MARTIN

Élégance & Charme



HOME SPIRIT

FRANCE



# CAP FERRET & SAINT MARTIN

## Élégance & Charme

MADE IN FRANCE



\* Option :

Point bourdon / Overcast stitch.

### CAP FERRET Profondeur 90 cm

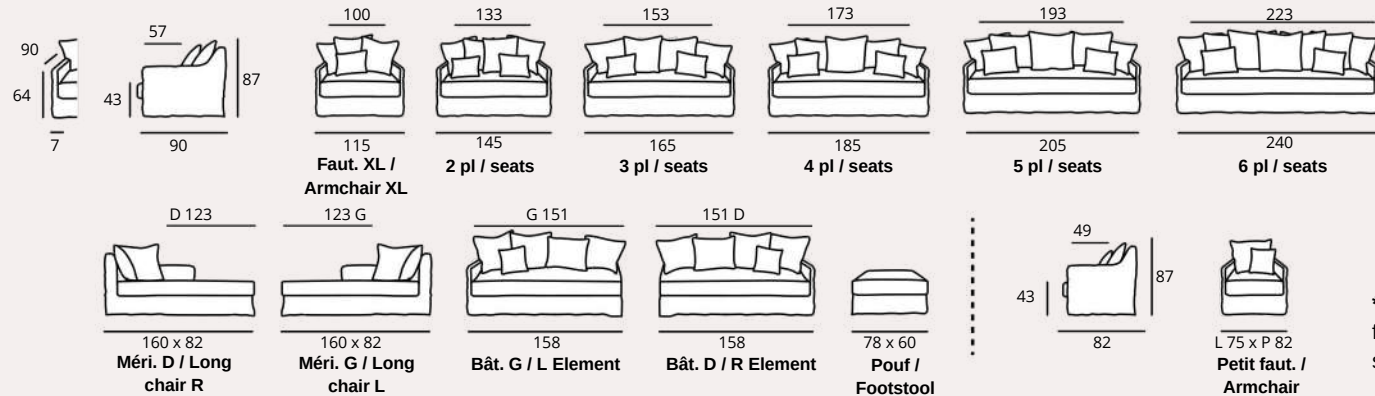

360°  
\* Option : petit  
fauteuil pivotant /  
swivel armchair

### SAINTE MARTIN Profondeur 100 cm

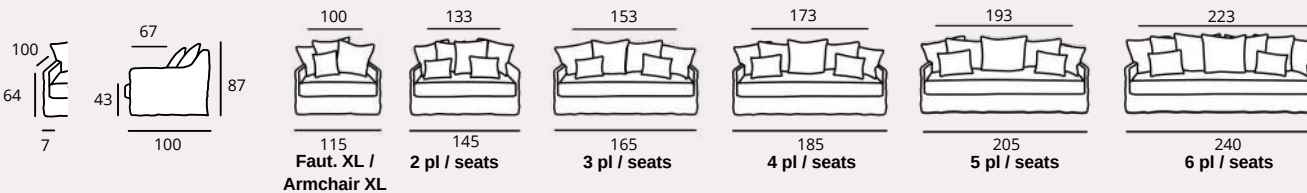

**Structure :** Hêtre, panneaux multiplex et panneaux de fibres. Structure enrobée de mousse polyuréthane et d'une sous-housse en foamé agrafée, suspension ressorts Nosags. **Assise :** Plumtex HR 35 kg/m<sup>3</sup> + percale remplissage plumes. **Dossier :** Coussins 60 x 60 cm, remplissage plumes/flocons. **Coussins de déco :** Coussins 45 x 45 cm, remplissage en plumes/flocons. **Pieds :** Bois. **Couture :** bord à bord / pincé. **Finition :** déhoussable. \*Option : Point bourdon - Convertible 6 cm - Petit fauteuil pivotant.

**Frame:** Beech wood, multiplex panels and fiber panels. Frame wrapped in foam cover. Suspension nosag springs. **Seat cushions:** Plumtex HR 35kg/m<sup>3</sup> + layer of feathers. **Back cushions:** cushions 60x60cm, feathers/foam flakes. **Deco cushions:** cushions 45x45cm, feathers/foam flakes. **Legs:** Wooden. **Sewing:** Pinched sewing. **Finish:** Removable covers. \*Option : Overcast stitch - Sofa bed 6 cm - Swivel armchair

**Nb de coussins (cushions number) :** Dos/Déco (back/deco) = Fauteuil : 1/1 - Faut. XL : 3/1 - 2 pl : 4/2 - 3 pl : 4/2 - 4 pl : 5/2 - 5 pl : 5/2 - 6 pl : 7/2 - Méridienne : 2/1 - Bâtard : 4/1.

HOME SPIRIT

FRANCE



homespirit.fr

MADE IN FRANCE

# CASSIS

Convertible Grand Confort 14cm



**HOME SPIRIT**

FRANCE

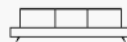



# CASSIS

## Convertible Grand Confort 14cm

MADE IN FRANCE

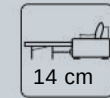
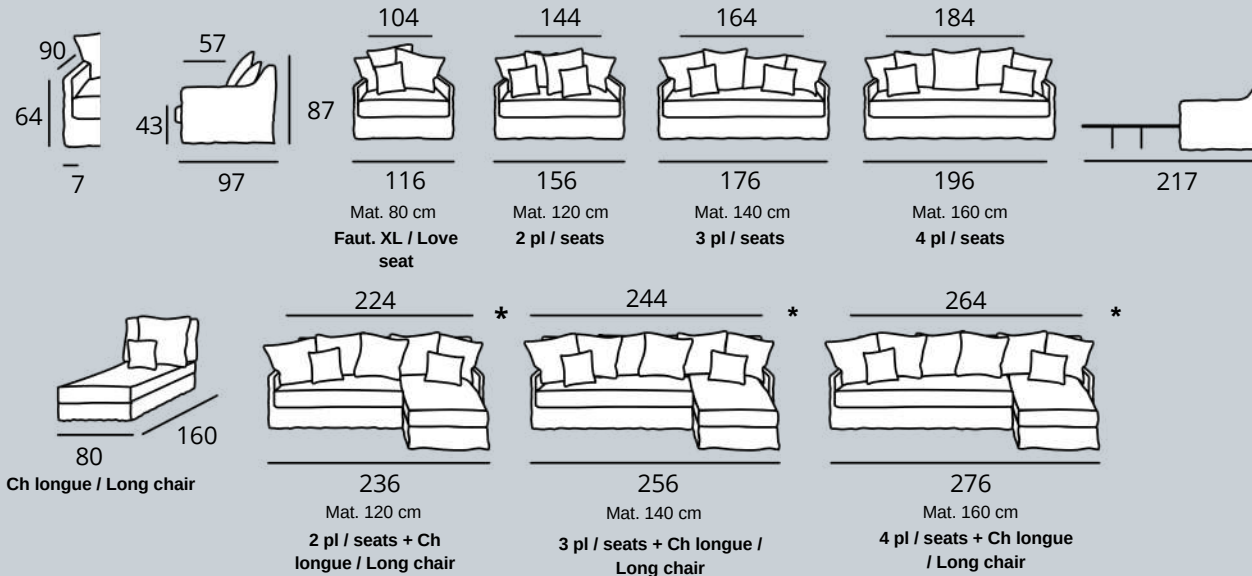

\*Angle réversible, méridienne repositionnable à gauche ou à droite

**Nb de coussins dossier (cushions number)**

: Arrière/Avant/Déco (back/front/deco) = Faut

XL : 1/3/1 - 2 pl : 2/4/2 - 3 pl : 2/4/2 - 4 pl :

2/5/2 - Méridienne : 1/1/1.

**Structure** : Hêtre, panneaux multiplex et panneaux de fibres. Mécanique autoporteuse sommier grille et sangles entrecroisées en pieds ou mécanique autoporteuse Black Edition sommier latte (bi-zone pour 3 et 4 places) et sangles entrecroisées en pieds. **Assise** : Plumtex HR 35 kg/m<sup>3</sup> + percale remplissage plumes. **Dossier** : **Arrière** : Deux grands coussins placés, mousse polyether 20 kg/m<sup>3</sup>. **Avant** : Coussins 60 x 60 cm, remplissage plumes/flocons. **Coussins de déco** : Coussins 45 x 45 cm, remplissage plumes/flocons. **Finition** : Déhoussable. **Matelas** : 14 cm Mousse HR Optimum 35 kg/m<sup>3</sup>. Dimensions : 80-120-140-160 x 200 cm. Assises et dossiers arrière restent en place à l'ouverture de la mécanique.

**Frame** : Solid beech wood, multiplex panels and fiber panels. **Selfsupporting bed mechanism** : Grid and elastic bands or selfsupporting bed mechanism Black Edition : slatted (bi-zone for 3 and 4 seats) and elastic bands. **Seat cushions**: Plumtex HR 35 kg/m<sup>3</sup> + layer of feathers. **Back cushions**: **Back**: rectangular cushions, polyether foam 20 kg/m<sup>3</sup>. **Front**: 60x60cm filled with feathers/foam flakes. **Deco cushions**: 45x45cm with feathers/foam flakes. **Finish**: Removable covers. **Mattress**: 14 cm thick, HR foam Optimum 35 kg/m<sup>3</sup>. Dimensions 80-120-140-160 x 200 cm. No need to remove rectangular back cushions and seat cushions when folding and unfolding.

HOME SPIRIT

FRANCE



homespirit.fr



MADE IN FRANCE

# CAP VERT & SAINT BARTH

Élégance & Charme



HOME SPIRIT

FRANCE



# CAP VERT & SAINT BARTH

## Élégance & Charme

MADE IN FRANCE



\* Option :  
Point bourdon / Overcast stitch.

### CAP VERT

Profondeur 90 cm

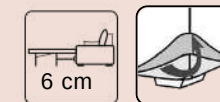
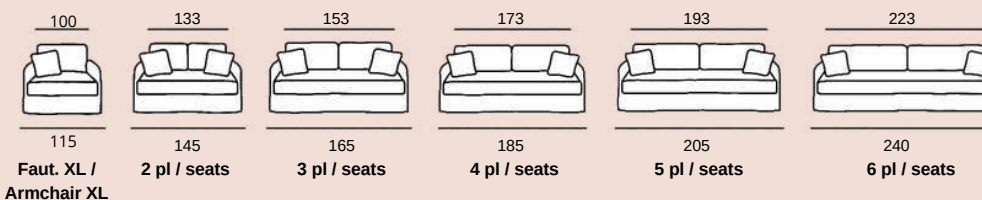
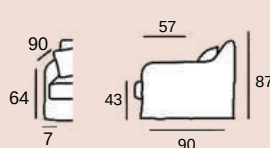

### SAINT BARTH

Profondeur 100 cm

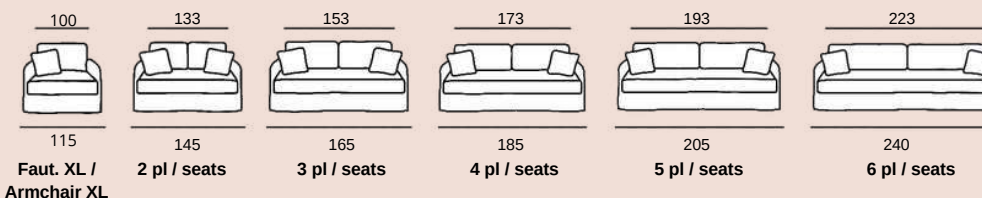
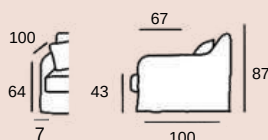

**Structure :** Hêtre, panneaux multiplex et panneaux de fibres. Structure enrobée de mousse polyuréthane et d'une sous-housse en foamé agrafée, suspension ressorts Nosags. **Assise :** Plumtex HR 35 kg/m<sup>3</sup> + percale remplissage plumes. **Dossier :** 2 coussins de dos, remplissage plumes/flocons. **Coussins de déco :** Coussins 45 x 45 cm, remplissage en plumes/flocons. **Pieds :** Bois. **Couture :** bord à bord / pincé. **Finition :** déhoussable. **\*Option :** Point bourdon - Convertible 6 cm.

**Frame:** Beech wood, multiplex panels and fiber panels. Frame wrapped in foam cover. Suspension nosags spings. **Seat cushions:** Plumtex HR 35kg/m<sup>3</sup> + layer of feathers. **Back cushions:** 2 cushions, feathers/foam flake. **Deco cushions:** cushions 45x45cm, feathers/foam flakes. **Legs:** Wooden. **Sewing:** Pinched sewing. **Finish:** Removable covers. **\*Option :** Overcast stitch - Sofa bed 6 cm.

HOME SPIRIT

FRANCE



homespirit.fr

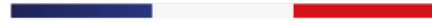

MADE IN FRANCE

# CHAMONIX

& CHAMBORD

Actuel & Moelleux



HOME SPIRIT

FRANCE

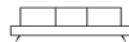



# CHAMONIX & CHAMBORD

## Actuel & Moelleux

MADE IN FRANCE

### CHAMONIX

Profondeur 110 cm

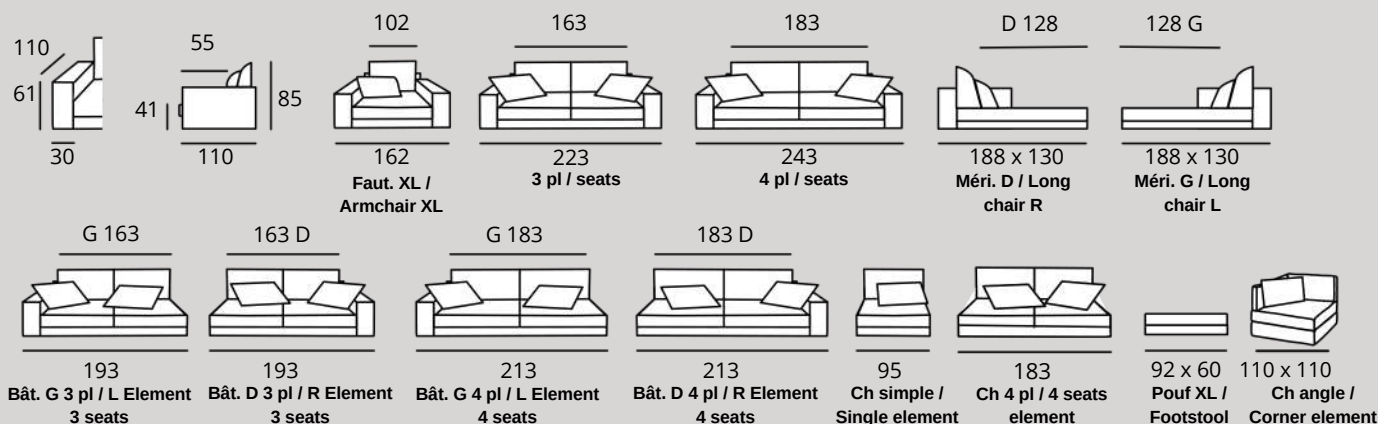

### CHAMBORD

Profondeur 100 cm

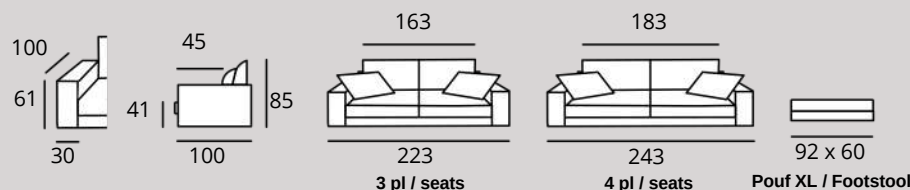

**Structure :** Hêtre, panneaux multiplex et panneaux de fibres. Structure enrobée de mousse polyuréthane. Manchette enrobée de ouate 650g et surmontée d'une percale en plumes, suspension ressorts Nosags. **Assise :** Plumtex mousse HR 35 kg/m<sup>3</sup> + percale de plumes. **Dossier :** **Arrière :** Coussins rectangulaires, remplissage plumes/flocons. **Avant :** Coussins remplissage plumes/flocons. **Coussins déco :** 2 coussins, remplissage plumes/flocons. **Pieds :** Bois. **Finition :** Tapissier.

**Frame:** Beech wood, multiplex and fiber panels. Frame wrapped in foam cover. Arm covered with a 650 g cotton-wool & double layered with a percale cover with feathers. Suspension nosags springs. **Seat cushions:** Plumtex HR foam 35 kg/m<sup>3</sup> + layer of feathers. **Back cushions:** **Back:** Rectangular cushions, feathers/foam flakes. **Front:** cushions filled with feathers/foam flakes. **Deco cushions:** 2 cushions filled with feathers/foam flakes. **Legs:** Wooden. **Finish:** Fixed covers.

HOME SPIRIT

FRANCE



homespirit.fr

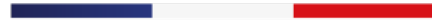

MADE IN FRANCE

# COLOGNE

Actuel & Moelleux



**HOME SPIRIT**

FRANCE



# COLOGNE

Actuel & Moelleux

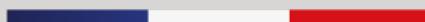

MADE IN FRANCE

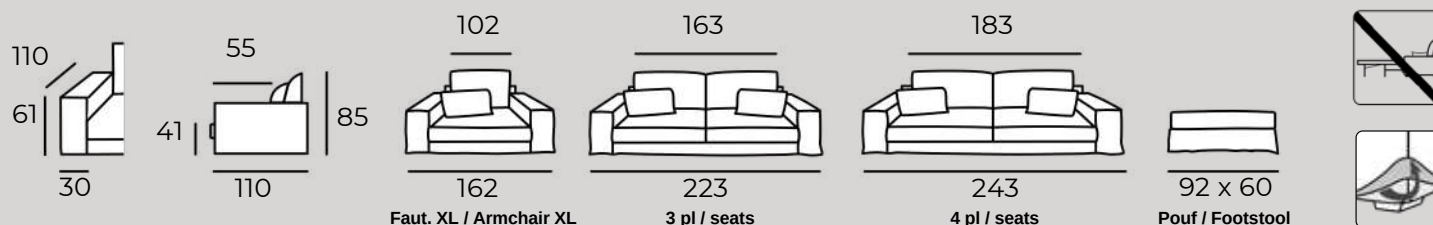

**Structure :** Hêtre, panneaux multiplex et panneaux de fibres. Structure enrobée de mousse polyuréthane. Manchette enrobée de ouate 650g et surmontée d'une percale en plumes, suspension ressorts Nosags. **Assise :** Plumtex mousse HR 35 kg/m<sup>3</sup> + percale de plumes. **Dossier : Arrière :** Coussins rectangulaires, remplissage plumes/flocons - **Avant :** Remplissage plumes/flocons. **Coussins déco :** 2 coussins remplissage plumes/flocons. **Pieds :** Bois. **Finition :** Déhoussable.

**Frame:** Beech wood, multiplex and fiber panels. Frame wrapped in foam cover. Arm covered with a 650 g cotton-wool & double layed with a percale cover with feathers. Suspension nosag springs. **Seat cushions:** Plumtex HR foam 35 kg/m<sup>3</sup> + layer of feathers - **Back cushions: Back:** Rectangular cushion, feathers/foam flakes - **Front:** cushions filled with feathers/foam flakes - **Deco cushions:** 2 cushions filled with feathers/foam flakes. **Legs:** Wooden. **Finish:** Removable covers.

HOME SPIRIT

FRANCE



homespirit.fr

MADE IN FRANCE

# FARO

Élégant & Audacieux



**HOME SPIRIT**

FRANCE

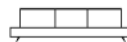



# FARO

## Élégant & Audacieux

MADE IN FRANCE

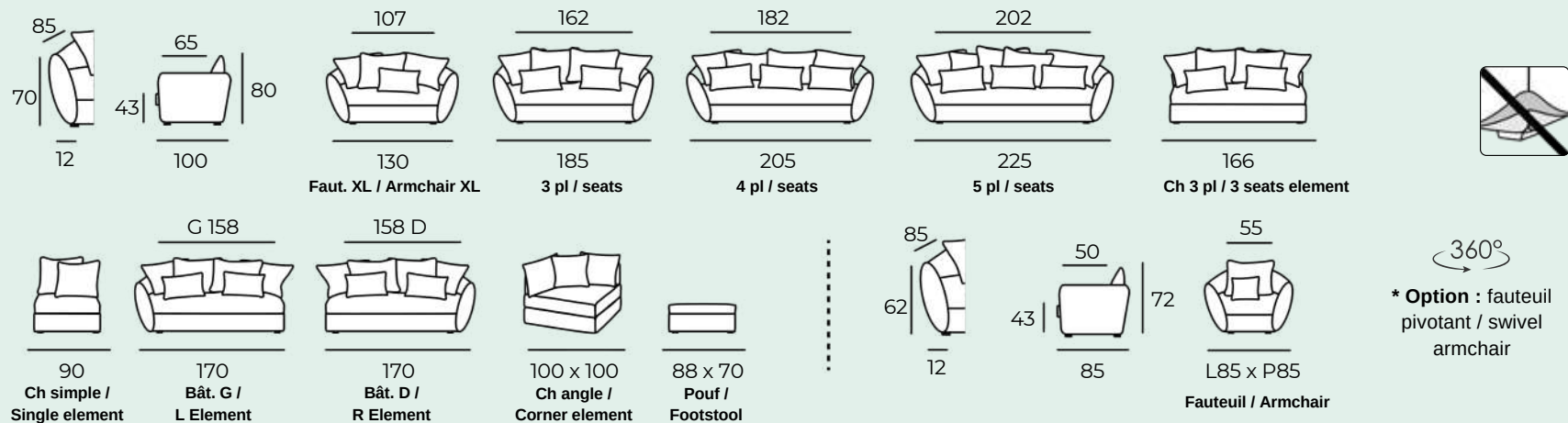

**Structure :** Hêtre, panneaux multiplex et panneaux de fibres. Structure enrobée de mousse polyuréthane et de ouate 650 g, suspension ressorts Nosags. **Assise :** Plumtex HR 35 kg/m<sup>3</sup> + percale remplissage plumes. **Dossier :** Coussins 60 x 60 cm, remplissage plumes/flocons. **Coussins déco :** Coussin 45 x 60 cm, remplissage plumes/flocons. **Pieds :** Bois. **Finition :** Tapissier. **\*Option :** Fauteuil pivotant.

**Frame:** Solid beech wood, multiplex panels and fiber panels. Frame wrapped in foam cover and double layered with a fiber cover. Suspension Nosags springs. **Seat cushions:** Plumtex HR 35 kg/m<sup>3</sup> + layer of feathers. **Back cushions:** Cushions 60x60cm, feathers/foam flakes. **Deco cushions:** Cushions 45x60cm, feathers/foam flakes. **Legs:** Wooden. **Finish:** Fixed covers. **\*Option :** Swivel armchair

**Nb de coussins (cushions number) :** Dos/Déco (back/deco) = Fauteuil : 1/1 - Fauteuil XL : 3/1 - 4 places : 4/3 - 5 places : 5/3 - Bâtard 3 places : 4/2 - Chauffeuse simple : 2/0 - Chauffeuse 3 places : 4/2 - Chauffeuse d'angle : 3/0 - Pouf : 0/0.

HOME SPIRIT

FRANCE



homespirit.fr

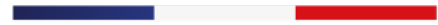

MADE IN FRANCE

# FIGARI

Élégant & Audacieux



# FIGARI

## Élégant & Audacieux

MADE IN FRANCE

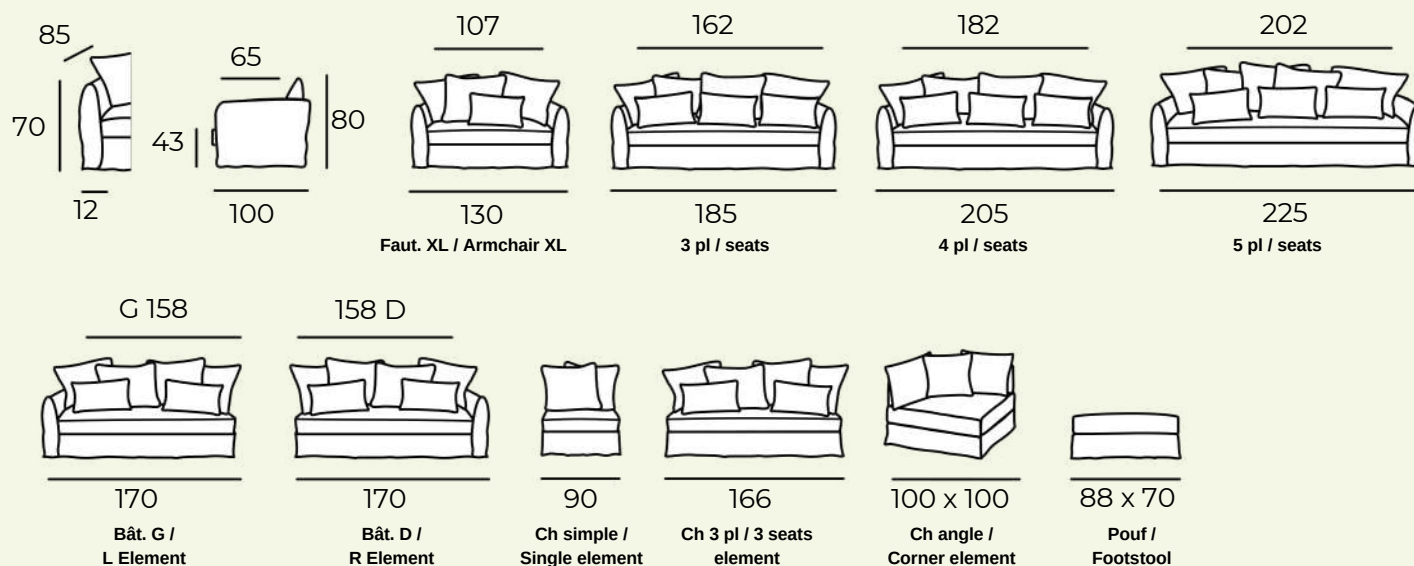

**Structure :** Hêtre, panneaux multiplex et panneaux de fibres. Structure enrobée de mousse polyuréthane et de ouate 650 g, suspension ressorts Nosags. **Assise :** Plumtex HR 35 kg/m<sup>3</sup> + percale remplissage plumes. **Dossier :** Coussins 60 x 60 cm, remplissage plumes/flocons. **Coussins déco :** Coussin 45 x 60 cm, remplissage plumes/flocons. **Pieds :** Bois. **Finition :** 100% déhoussable.

**Frame:** Solid beech wood, multiplex panels and fiber panels. Frame wrapped in foam cover and double layered with a fiber cover. Suspension Nosag springs. **Seat cushions:** Plumtex HR 35 kg/m<sup>3</sup> + layer of feathers. **Back cushions:** Cushions 60x60cm, feathers/foam flakes. **Deco cushions:** Cushions 45x60cm, feathers/foam flakes. **Legs:** Wooden. **Finish:** Removable covers.

**Nb de coussins (cushions number) :** Dos/Déco (back/deco) = Fauteuil XL : 3/1 - 3 places : 4/3 - 4 places : 4/3 - 5 places : 5/3 - Bâtard 3 places : 4/2 - Chauffeuse simple : 2/0 - Chauffeuse 3 places : 4/2 - Chauffeuse d'angle : 3/0 - Pouf : 0/0 - Fauteuil XL+Pouf : 3/1.

HOME SPIRIT



homespirit.fr

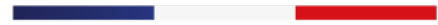

MADE IN FRANCE

# FIGEAC

Chic & Généreux





# FIGEAC

## Chic & Généreux

MADE IN FRANCE

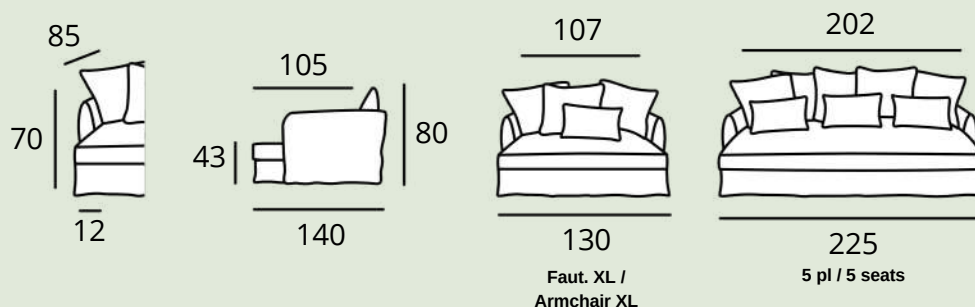

**Structure** : Hêtre, panneaux multiplex et panneaux de fibres. Structure enrobée de mousse polyuréthane et de ouate 650 g, suspension ressorts Nosags. **Assise** : Plumtex HR 35 kg/m<sup>3</sup> + percale remplissage plumes. **Dossier** : Coussins 60 x 60 cm, remplissage plumes/flocons. **Coussins déco** : Coussin 45 x 60 cm, remplissage plumes/flocons. **Pieds** : Bois. **Finition** : 100% déhoussable.

**Frame**: Solid beech wood, multiplex panels and fiber panels. Frame wrapped in foam cover and double layered with a fiber cover. Suspension No-sags springs. **Seat cushions**: Plumtex HR 35 kg/m<sup>3</sup> + layer of feathers. **Back cushions**: Cushions 60x60cm, feathers/foam flakes. **Deco cushions**: Cushions 45x60cm, feathers/foam flakes. **Legs**: Wooden. **Finish**: Removable covers.

**Nb de coussins (cushions number)** : Dos/Déco (back/deco) = Fauteuil XL : 3/1 - 5 places : 5/3.

Modèle composé d'un canapé et d'un élément type pouf, à fixer à l'aide de pinces crocodiles.

*Sofa with two elements, to assemble with crocodile clips.*



homespirit.fr

MADE IN FRANCE

# NOMAD

Confortable & Généreux



**HOME SPIRIT**

FRANCE

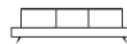

# NOMAD

## Confortable & Généreux

MADE IN FRANCE

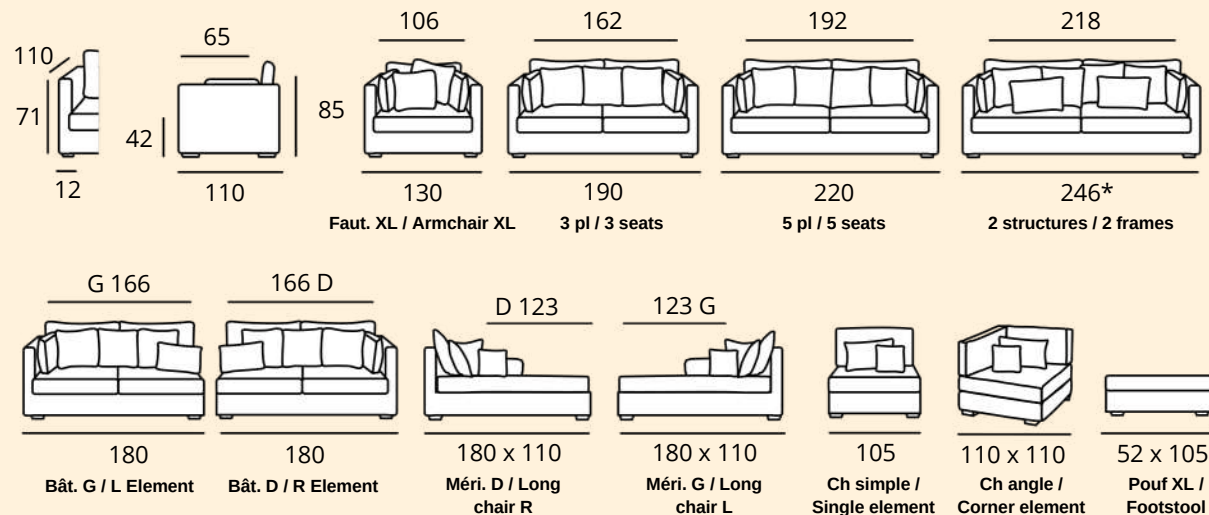

**Structure** : Hêtre, panneaux multiplex et panneaux de fibres. Structure enrobée de mousse polyuréthane et d'une sous-housse en foamé agrafée, suspension ressorts Nosags. **Assise** : Plumtex HR 35 kg/m<sup>3</sup> + percale remplissage plumes. **Dossier** : **Arrière** : Coussins rectangulaires, remplissage plumes/flocons - **Avant** : Coussins 45 x 45 cm, remplissage plumes/flocons. **Coussins accoudoirs** : Coussin 60 x 40 cm, remplissage plumes/flocons. **Pieds** : Bois. **Finition** : Déhoussable. \* La caisse du canapé 246 cm est livrée en 2 pièces : 2 structures de bâtard de 123 cm avec une housse unique de 246 cm.

**Frame**: Beech wood, multiplex and fiber panels. Frame wrapped in foam cover. Suspension Nosags springs. **Seat cushions**: Plumtex HR foam 35 kg/m<sup>3</sup> + layer of feathers. **Back cushions**: **Back**: Rectangular cushions, feathers/foam flakes - **Front**: Cushion 45x45 cm, filled with feathers/foam flakes. **Arm cushion**: Cushion 60x40cm, filled with feathers/foam flakes. **Legs**: Solid wooden. **Finish**: Removable covers. \* Sofa 246 cm is made of 2 frames : with one unique fabric cover on the structure.

**Nb de coussins dossier (cushions number)** : Arrière/Avant/Accoudoirs (back/front/arm) = Faut XL : 1/2/2 - 3 pl : 2/3/2 - 5 pl : 2/4/2 - 6 pl : 2/4/4 - Bâtard : 2/3/2 - Méridienne : 1/2/1 - Ch simple : 1/1/1 - Ch angle : 2/1/1.

HOME SPIRIT

FRANCE



homespirit.fr

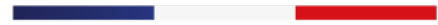

MADE IN FRANCE

# PETER

Urbain & Raffiné

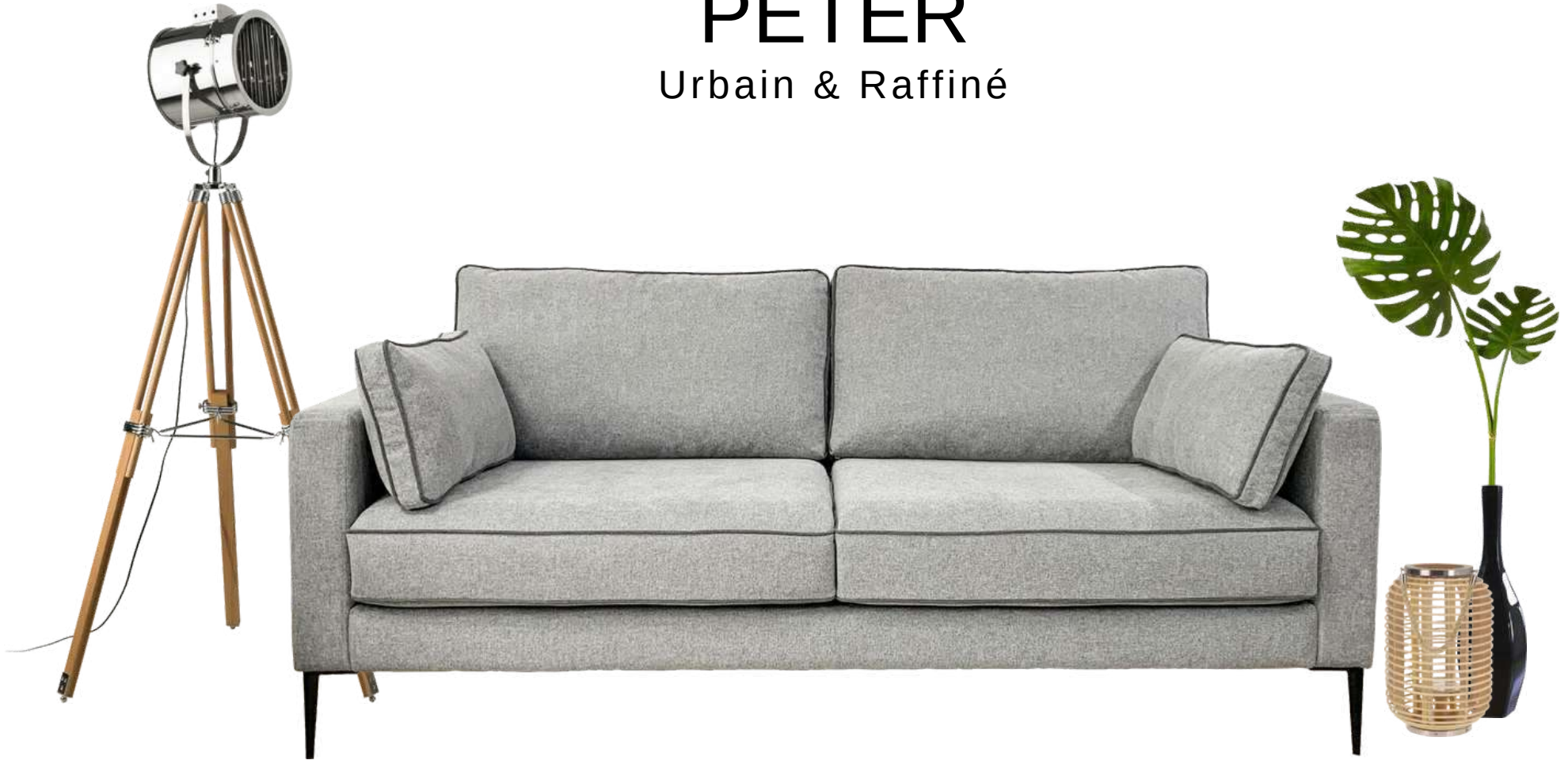

**HOME SPIRIT**

FRANCE

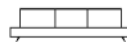



# PETER

## Urbain & Raffiné

MADE IN FRANCE

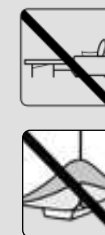
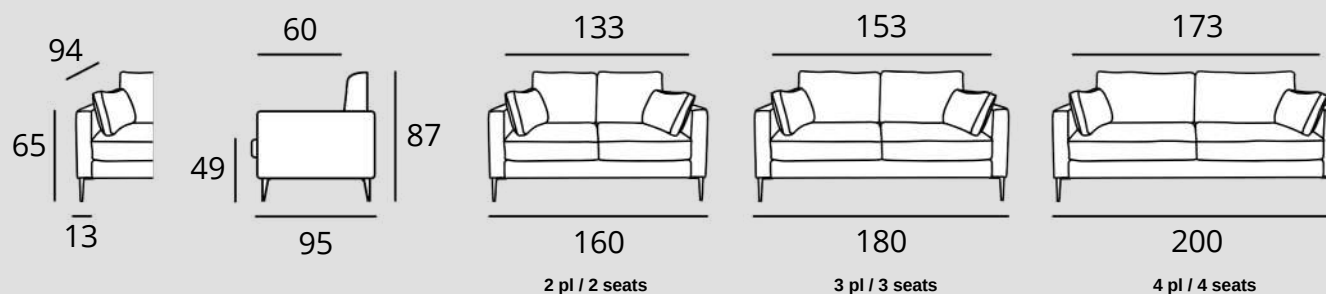

**Structure** : Bois massif, panneaux de fibres et panneaux de particules. **Assise** : Mousse HR 35 kg/m<sup>3</sup> + HR 26 kg/m<sup>3</sup>. **Dossier** : Coussins rectangulaires, remplissage fibres creuses siliconées. **Coussins déco** : 2 x coussins 60 x 30 cm, remplissage fibres. **Pieds** : Métal - noir - hauteur 17 cm. **Couture** : Surpiqûre plate sur la structure. Passepoil sur les coussins d'assise, de dos et de déco. **Finition** : Tapissier.

**Frame**: Solid beech wood, fiber panels and multiplex panels. **Seat cushions**: HR foam 35 kg/m<sup>3</sup> + HR 26 kg/m<sup>3</sup>. **Back cushions**: Fibers. **Deco cushion**: 60x30cm fibers. **Legs**: Metal - black - height 17 cm. **Sewing**: Flat topstitch on the frame. Piping on seat, back and deco cushions. **Finish**: Fixed covers.



homespirit.fr

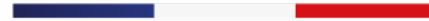

MADE IN FRANCE

# SPENCER

Intemporel & Compact



**HOME SPIRIT**

FRANCE

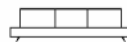

# SPENCER

## Intemporel & Compact

MADE IN FRANCE

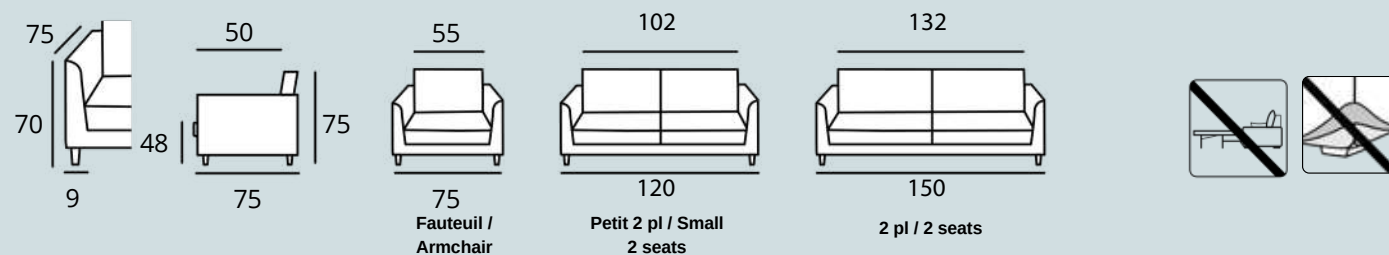

**Structure** : Hêtre, panneaux multiplex et panneaux de fibres. Structure enrobée de mousse polyuréthane et d'une sous-housse en foamé agrafée, suspension sangles. **Assise** : Mousse HR 35 kg/m<sup>3</sup> + HR 23 kg/m<sup>3</sup>. **Dossier** : Remplissage fibres creuses siliconées. **Pieds** : Métal noir. **Finition** : Tapissier.

**Frame**: Beech wood, multiplex and fiber panels. Frame wrapped in foam cover. Suspension elastic bands. **Seat cushions**: HR foam 35 kg/m<sup>3</sup> + HR foam 23 kg/m<sup>3</sup>. **Back cushions**: fibers. **Legs** : Black metal. **Finish**: Fixed covers.

HOME SPIRIT

FRANCE



homespirit.fr

MADE IN FRANCE

# TACOMA

Compact & Réversible



HOME SPIRIT

FRANCE

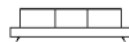



# TACOMA

## Compact & Réversible

MADE IN FRANCE

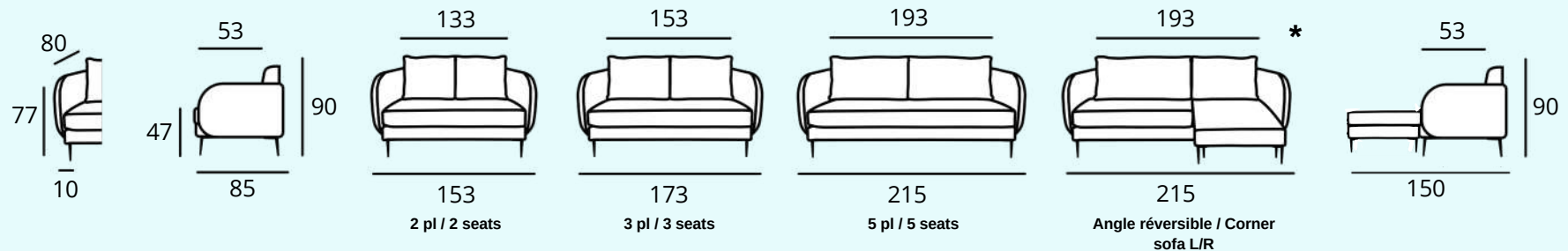

**Structure :** Bois massif, panneaux de fibres et panneaux de particules. Suspension d'assise ressorts Nosags. **Assise :** Mousse HR 35 kg/m<sup>3</sup> + HR 26 kg/m<sup>3</sup> - Coussin mono-assise pour 2 pl, 3 pl et 5 pl - Deux assises pour l'angle. **Dossier :** Coussins rectangulaires, remplissage fibres creuses siliconées. **Pieds :** Métal - noir - hauteur 17 cm. **Couture :** Sellier. **Finition :** Tapissier.

**Frame:** Solid beech wood, fiber panels and multiplex panels. Suspension Nosags springs. **Seat cushions:** HR foam 35 kg/m<sup>3</sup> + HR 26 kg/m<sup>3</sup>. Only one cushion for 2 seats, 3 seats and 5 seats - Two cushions for corner sofa. **Back cushions:** Fibers. **Legs:** Metal - black - height 17 cm. **Sewing:** Double stitching. **Finish:** Fixed covers.

\* Canapé d'angle réversible composé d'un canapé et d'un pouf : pouf, assises et dossiers repositionnables à gauche ou à droite.  
Reversible corner sofa including sofa + footstool : footstool, seats and back cushions can be set on the left or on the right.

HOME SPIRIT

FRANCE



homespirit.fr

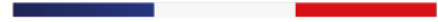

MADE IN FRANCE

# VANG

Contemporain & Épuré



**HOME SPIRIT**

FRANCE

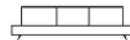

# VANG

## Contemporain & Épuré

MADE IN FRANCE

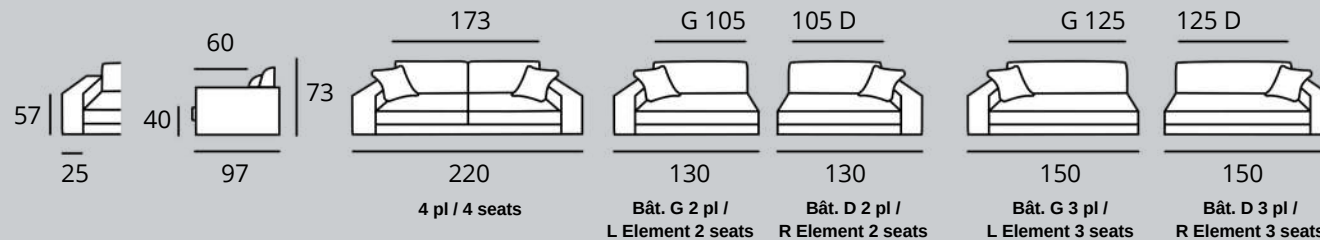

**Structure** : Hêtre, panneaux multiplex et panneaux de fibres. Structure enrobée de mousse polyuréthane et d'une housse en foamé aggrafée. Suspension ressorts Nosags. **Assise** : Mousse HR 35 kg/m<sup>3</sup> + HR 25 kg/m<sup>3</sup>. **Dossier** : Coussins rectangulaires, fibres creuses siliconées. **Coussins déco** : Remplissage plumes/flocons. **Pieds** : Bois. **Finition** : Tapissier.

**Frame**: Beech wood, multiplex panels and fiber panels. Frame wrapped in polyurethane foam with a white foam cover. Suspension Nosag springs. **Seat cushions**: HR 35 kg/m<sup>3</sup> + HR 25 kg/m<sup>3</sup>. **Back cushions**: Rectangular cushions, filled with fibers. **Deco cushions**: Filled with feathers/foam flakes. **Legs**: Wooden. **Finish**: Fixed covers.

HOME SPIRIT

FRANCE



homespirit.fr





MADE IN FRANCE

# GAMME COUSSINS

HOME SPIRIT

FRANCE



# GAMME COUSSINS



MADE IN FRANCE



45 x 45

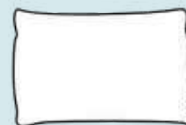

30 x 50



40 x 60

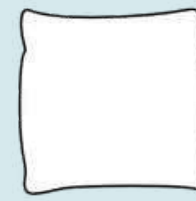

60 x 60

**Voir l'ensemble de l'offre sur le tarif.**  
***See the whole range of cushions on the price list.***

**HOME SPIRIT**



homespirit.fr

MADE IN FRANCE

# POUF, DOMINO & TÊTIÈRE

Personnalisés & Pétillants



HOME SPIRIT

FRANCE

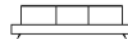

# POUF, DOMINO & TÊTIÈRE

Personnalisés & Pétillants



MADE IN FRANCE

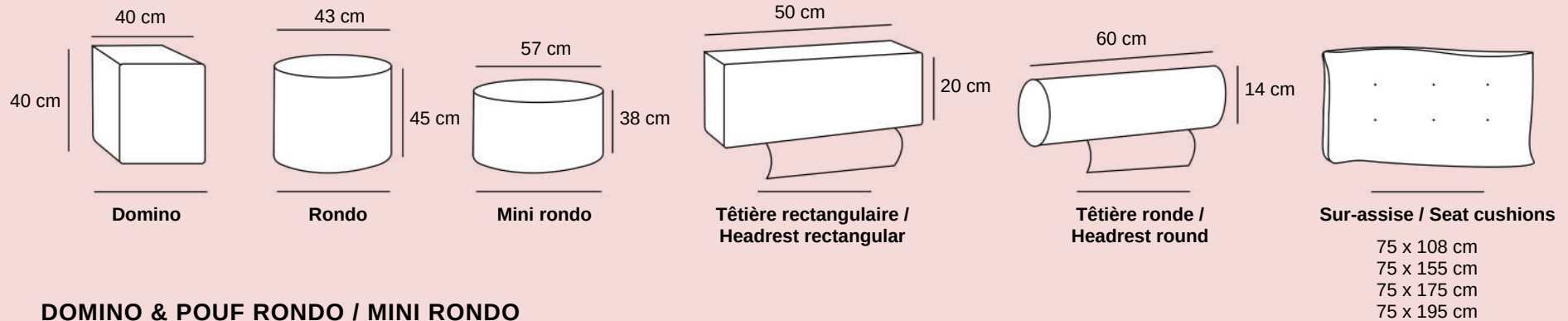

## DOMINO & POUF RONDO / MINI RONDO

**Structure :** Hêtre. Panneaux multiplex. Structure enrobée de mousse polyuréthane. **Finition :** Tapissier.

**Frame:** Beech wood. Multiplex panels. Frame wrapped in foam cover. **Finish:** Fixed covers.

## TÊTIÈRE RECTANGULAIRE OU RONDE / HEADREST

**Structure :** Mousse 17 kg/m<sup>3</sup>, support métal. **Finition :** Déhoussable

**Frame:** Foam 17 kg/m<sup>3</sup>, metal support. **Finish:** Removable covers.

## SUR-ASSISE / SEAT CUSHIONS

**Structure :** Remplissage fibre. **Finition :** Passepoil.

**Frame:** Filled with fibers, **Finish:** Stitching in piping.



homespirit.fr

MADE IN FRANCE

# Retrouvez nous sur [www.homespirit.fr](http://www.homespirit.fr)

