



GAMME

Gold

PERSONNALISEZ VOTRE CANAPÉ
AU FIL DE VOS ENVIES

- JANVIER 2025 -

HOME SPIRIT

FRANCE



FORMULE FLASH

4 modèles / models
8 tailles / sizes
2 tissus / fabrics

Fabrication sous 1 semaine
Manufactured in 1 week

BIARRITZ



3 pl / seats

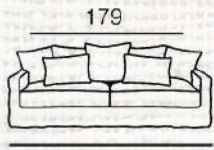

206

4 pl / seats

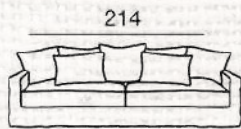

240

BISCARROSSE



3 pl / seats

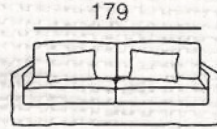

206

4 pl / seats

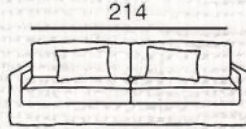

240

CAP FERRET



4 pl / seats

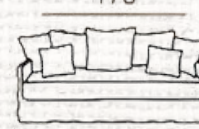

185

5 pl / seats

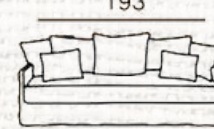

205

BIDART



3 pl / seats

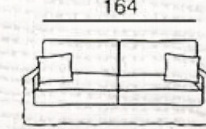

190
Mat. 140 cm

4 pl / seats

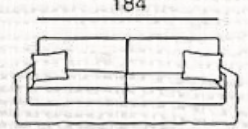

210
Mat. 160 cm

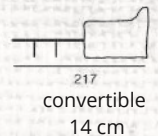

217
convertible
14 cm

CHOIX DU TISSU
FABRIC SELECTION



SWEET
ECRÚ

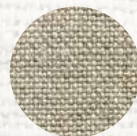

NEWLIN
NATUREL

HOME SPIRIT

FRANCE

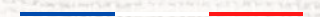
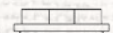

MADE IN FRANCE

1965

Accueillant & Rétro



HOME SPIRIT

FRANCE

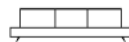

1965

Accueillant & Rétro

MADE IN FRANCE

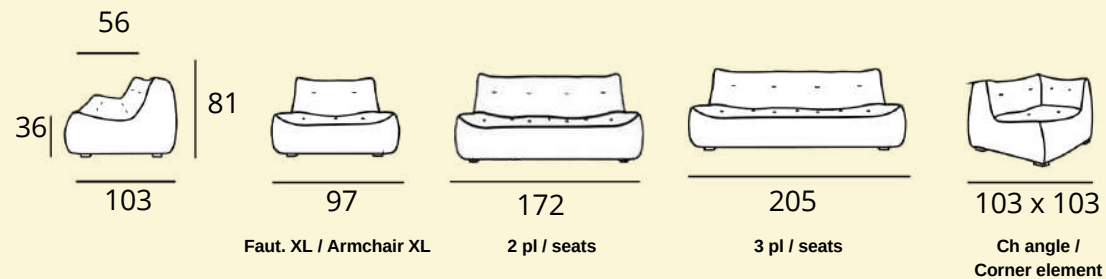

Structure : Mousse HR 35 kg/m³, mousse polyéther 17 kg/m³ + HR 26 kg/m³, posé sur un panneau de bois. **Pieds :** Bois. **Finition :** Tapissier.

Frame: HR foam 35 kg/m³, HR foam 35 kg/m³ + polyether foam 17 kg/m³ + HR 26 kg/m³, on a wooden panel. **Legs:** Wood. **Finish:** Fixed cover.

HOME SPIRIT

FRANCE



homespirit.fr

MADE IN FRANCE

ALBI

Aisance & Volume



HOME SPIRIT

FRANCE

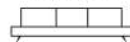

ALBI

Aisance & Volume

MADE IN FRANCE

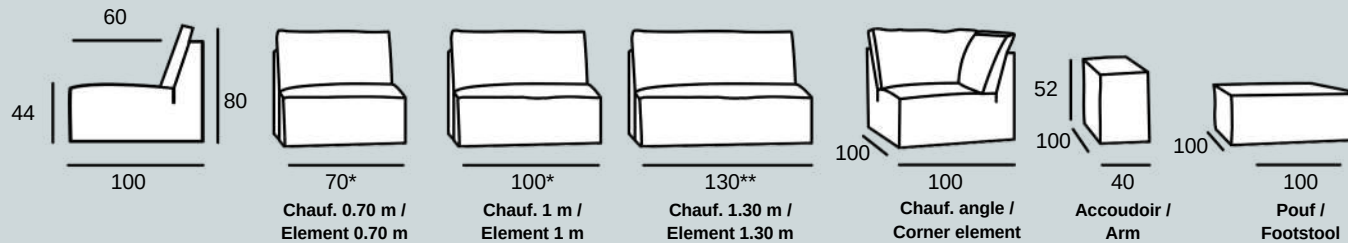

Option : largeur sur mesure : * de 70 à 100 cm. ** de 100 à 130 cm.

Option: custom made elements: * from 70 to 100 cm. ** from 100 to 130 cm.

Structure : Hêtre, panneaux multiplex et panneaux de fibres. Structure enrobée de mousse polyuréthane. Manchette enrobée de ouate 650 g. Suspension ressorts Nosags. **Assise :** HR 35 kg/m³ + HR 25 kg/m³ + ouate. **Dossier :** remplissage plumes/flocons. **Couture :** Bord à bord, pincé. **Pieds :** Plastique. **Finition :** tapissier, non convertible.

Frame: Solid beech wood, multiplex panels and fiber panels . Frame wrapped in foam cover and double layered with a fiber cover. Suspension Nosags springs. **Seat cushions:** HR foam 35 kg/m³ + HR foam 25 kg/m³ + cotton-wool. **Back cushions:** Feathers/foam flakes. **Sewing:** Pinched sewing. **Legs:** Plastic. **Finish:** Fixed covers.

HOME SPIRIT

FRANCE



homespirit.fr

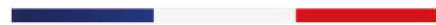

MADE IN FRANCE

ARLES

Aisance & Volume



HOME SPIRIT

FRANCE

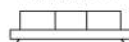

ARLES

Aisance & Volume

MADE IN FRANCE

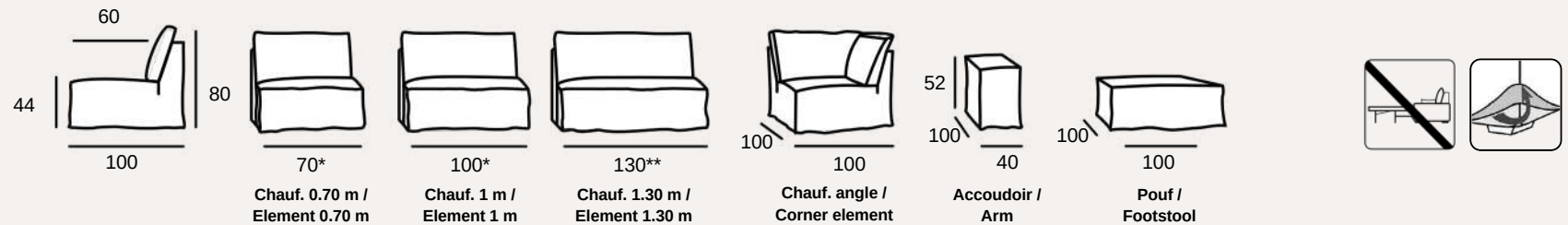

Option : largeur sur mesure : * de 70 à 100 cm. ** de 100 à 130 cm.

Option: custom made elements: * from 70 to 100 cm. ** from 100 to 130 cm.

Structure : Hêtre, panneaux multiplex et panneaux de fibres. Structure enrobée de mousse polyuréthane. Manchette enrobée de ouate 650 g. Suspension ressorts Nosags. **Assise :** HR 35 kg/m³ + HR 25 kg/m³ + ouate. **Dossier :** remplissage plumes/flocons. **Couture :** Surpiqûre plate. **Pieds :** Plastique. **Finition :** 100% déhoussable, non convertible.

Frame: Solid beech wood, multiplex panels and fiber panels . Frame wrapped in foam cover and double layered with a fiber cover. Suspension Nosags springs. **Seat cushions:** HR foam 35 kg/m³ + HR foam 25 kg/m³ + cotton-wool. **Back cushions:** Feathers/foam flakes. **Sewing:** Flat topstitching. **Legs:** Plastic. **Finish:** Removable covers.

HOME SPIRIT

FRANCE



homespirit.fr

MADE IN FRANCE

AUSTIN

Caractère & Éléance



HOME SPIRIT

FRANCE

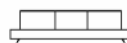

AUSTIN

Caractère & Éléance

MADE IN FRANCE

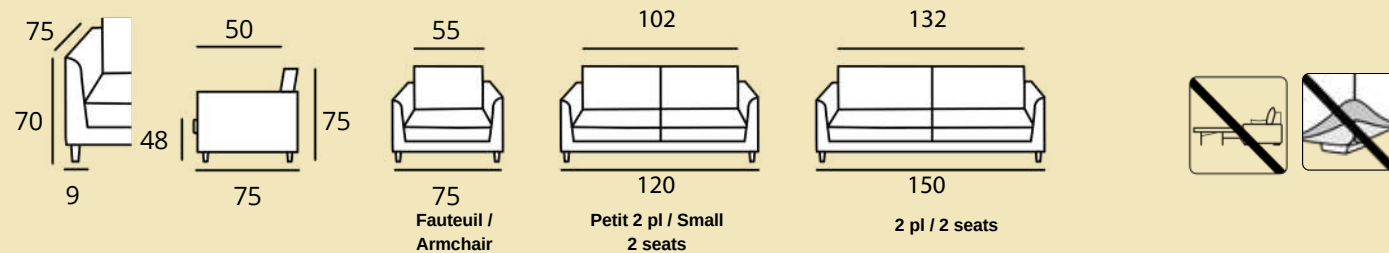

Structure : Hêtre, panneaux multiplex et panneaux de fibres. Structure enrobée de mousse polyuréthane et d'une sous-housse en foamé agrafée, suspension sangles. **Assise** : Mousse HR 35 kg/m³ + HR 23 kg/m³. **Dossier** : Remplissage fibres creuses siliconées. **Pieds** : Bois wengé. **Finition** : Tapissier.

Frame: Beech wood, multiplex and fiber panels. Frame wrapped in foam cover. Suspension elastic bands. **Seat cushions**: HR foam 35 kg/m³ + HR foam 23 kg/m³. **Back cushions**: fibers. **Legs** : Wooden in wenge color. **Finish**: Fixed covers.

HOME SPIRIT

FRANCE



homespirit.fr

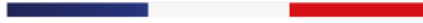

MADE IN FRANCE

BANDOL

Confort & Naturel



HOME SPIRIT

FRANCE



BANDOL

Confort & Naturel

MADE IN FRANCE

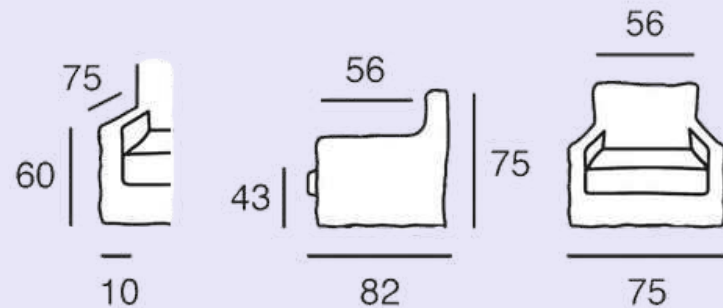

Fauteuil / Armchair



* Option : pivotant / swivel



Structure : Hêtre, panneaux multiplex et panneaux de fibres. Structure enrobée de mousse polyuréthane et d'une sous-housse en foamé agrafée, suspension ressorts Nosags. **Assise** : Plumtex HR 35 kg/m³ + percale remplissage plumes. **Pieds** : Bois. **Finition** : Déhoussable.
*Option : Fauteuil pivotant

Frame: Beech wood, multiplex and fiber panels. Frame wrapped in foam cover. Suspension Nosag springs.
Seat cushions: Plumtex HR foam 35 kg/m³ + layer of feathers. **Legs:** Wooden. **Finish:** Removable covers.
*Option : Swivel armchair



homespirit.fr

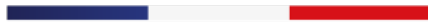

MADE IN FRANCE

BIARRITZ & BONDUES

Charme & Naturel



HOME SPIRIT

FRANCE



BIARRITZ & BONDUES

Charme & Naturel

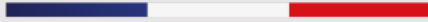

MADE IN FRANCE

BIARRITZ Profondeur 100 cm

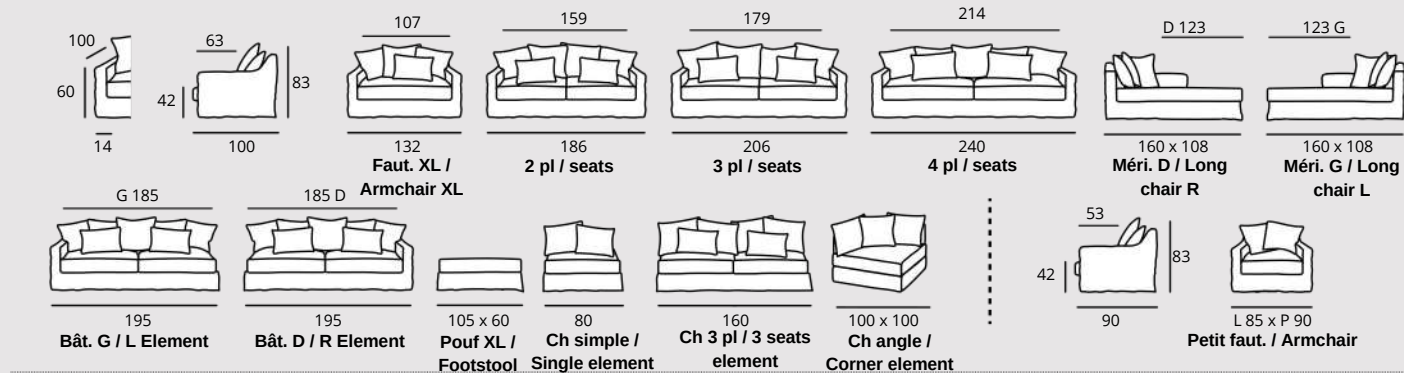

BONDUES Profondeur 90 cm

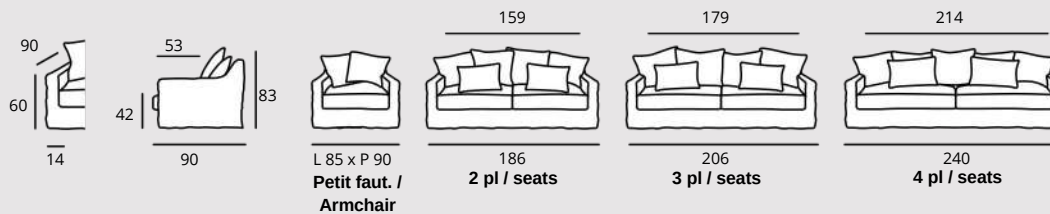

Structure : Hêtre, panneaux multiplex et panneaux de fibres. Structure enrobée de mousse polyuréthane et d'une sous-housse en foamé agrafée, suspension ressorts Nosags. **Assise** : Plumtex HR 35 kg/m³ + percale remplissage plumes. **Dossier** : Coussins 60x60 cm, remplissage plumes/flocons. **Coussins de déco** : Remplissage plumes/flocons, 60x45 cm. **Pieds** : Bois. **Finition** : Déhoussable. *Option : Petit fauteuil pivotant

Frame: Beech wood, multiplex and fiber panels. Frame wrapped in foam cover. Suspension no-sag springs. **Seat cushions**: Plumtex HR foam 35 kg/m³ + layer of feathers. **Back cushions**: cushions 60x60 cm, feathers/foam flakes. **Deco cushions**: cushions 60x45 cm, feathers/foam flakes. **Legs**: Wooden. **Finish**: Removable covers. *Option : Swivel armchair

Nb de coussins (cushions number) : Dos/Déco (back/deco) = Fauteuil : 1/1 - Faut XL : 3/1 - 2 pl : 4/2 - 3 pl : 4/2 - 4 pl : 5/2 - Méridienne : 2/1 - Bâtard : 5/2 - Ch simple : 2/0 - Ch double : 4/2 - Ch angle : 3/0.



homespirit.fr

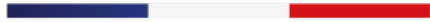

MADE IN FRANCE

BISCARROSSE & BRUGES

Charme & Naturel



HOME SPIRIT

FRANCE



BISCARROSSE & BRUGES

Charme & Naturel

MADE IN FRANCE

BISCARROSSE
Profondeur 100 cm

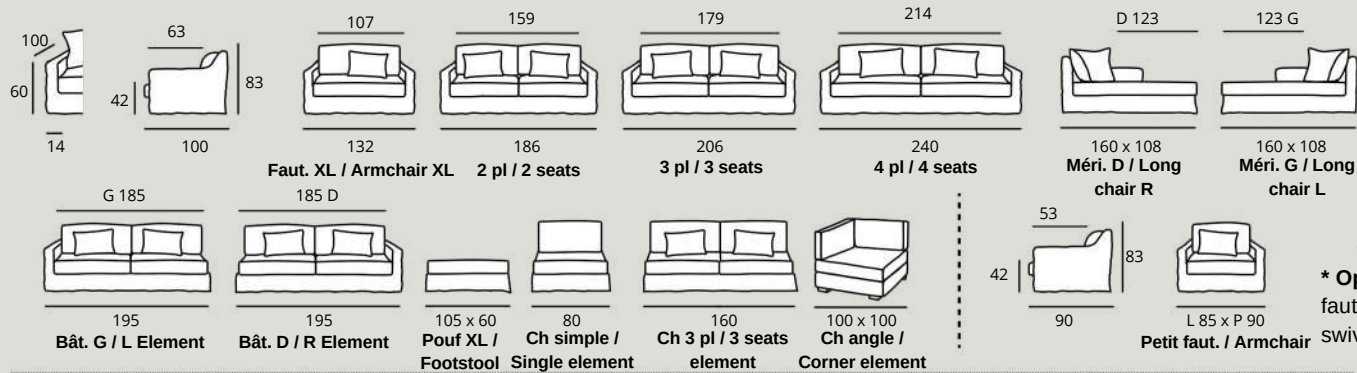

BRUGES
Profondeur 90 cm

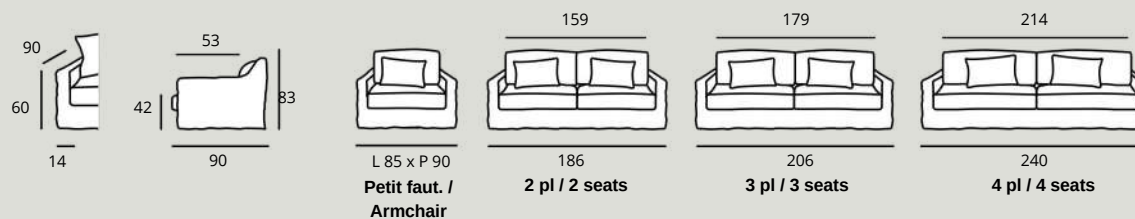

Structure : Hêtre, panneaux multiplex et panneaux de fibres. Structure enrobée de mousse polyuréthane et d'une sous-housse en foamé agrafée, suspension ressorts Nosags. **Assise** : Plumtex HR 35 kg/m³ + percale remplissage plumes. **Dossier** : Coussins rectangulaires, remplissage plumes/flocons. **Coussins de déco** : Remplissage plumes/flocons, 60x45 cm. **Pieds** : Bois. **Finition** : Déhoussable. ***Option** : Petit fauteuil pivotant

Frame: Beech wood, multiplex and fiber panels. Frame wrapped in foam cover. Suspension no-sag springs. **Seat cushions**: Plumtex HR foam 35 kg/m³ + layer of feathers. **Back cushions**: rectangular cushions, feathers/foam flakes. **Deco cushions**: cushions 60x45 cm, feathers/foam flakes. **Legs**: Wooden. **Finish**: Removable covers. ***Option** : Swivel armchair

HOME SPIRIT

FRANCE



homespirit.fr

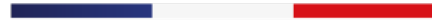

MADE IN FRANCE

BIDART

Convertible Grand Confort 14cm



HOME SPIRIT

FRANCE



BIDART

Convertible Grand Confort 14cm

MADE IN FRANCE

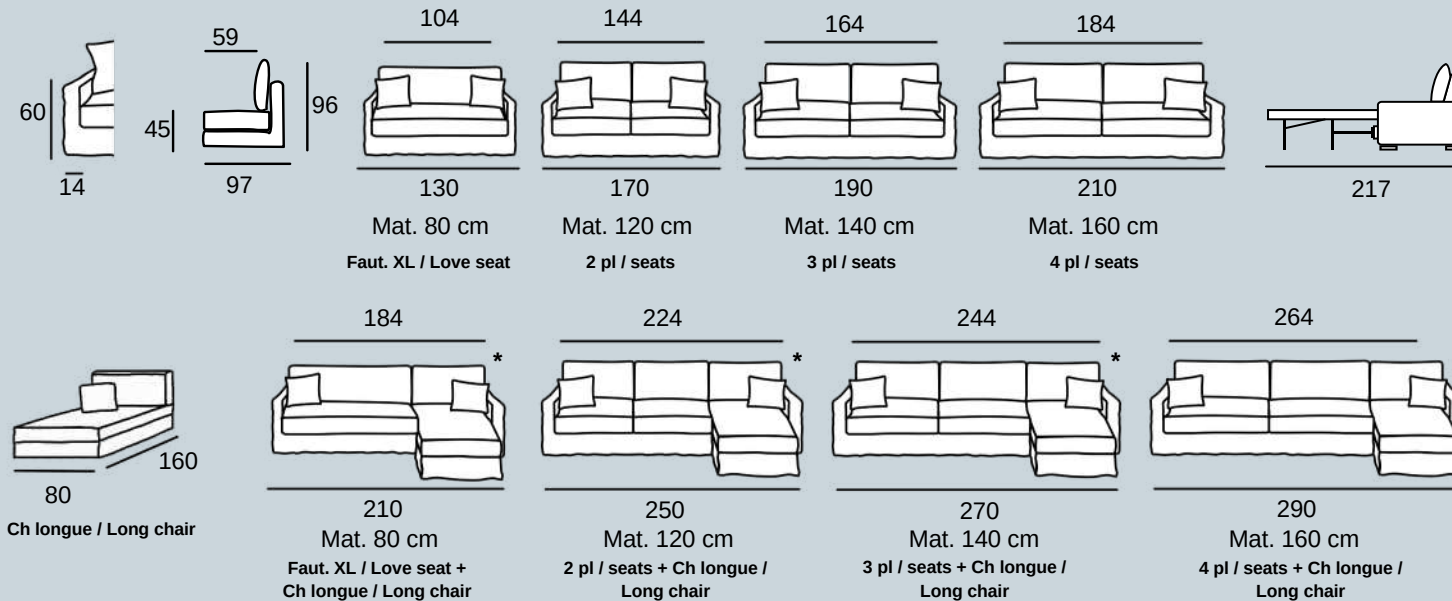

*Angle réversible à gauche ou à droite
*Corner réversible R/L

Structure : Hêtre, panneaux multiplex et panneaux de fibres. Mécanique autoporteuse sommier grille et sangles entrecroisées en pieds ou mécanique autoporteuse Black Edition sommier latte (bi-zone pour 3 et 4 places) et sangles entrecroisées en pieds. **Assise** : Plumtex HR 35 kg/m³ + percale remplissage plumes. **Dossier** : remplissage plumes/flocons. **Coussins de déco** : Coussins 60 x 45 cm, remplissage plumes/flocons. **Finition** Déhoussable. **Pieds** : Bois. **Matelas** : 14 cm Mousse HR Optimum 35 kg/ m³. Dimensions : 80-120-140-160 x 200 cm. Assises et dossiers restent en place à l'ouverture de la mécanique.

Frame: Solid beech wood, multiplex panels and fiber panels. **Selfsupporting bed mechanism** : Grid and elastic bands or selfsupporting bed mechanism Black Edition : slatted (bi-zone for 3 and 4 seats) and elastic bands. **Seat cushions**: Plumtex HR 35 kg/m³ + layer of feathers. **Back cushions**: filled with feathers/foam flakes. **Deco cushions**: cushions 60 x 45 cm, feathers/foam flakes. **Finish**: Removable covers. **Legs**: Wooden. **Mattress**: 14 cm thick, HR foam Optimum 35 kg/m³. Dimensions 80-120-140-160 x 200 cm. No need to remove back and seat cushions when folding and unfolding.

HOME SPIRIT



homespirit.fr

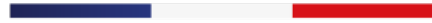

MADE IN FRANCE

BLAGNAC

Élégant & Intemporel



HOME SPIRIT

FRANCE

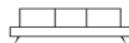

BLAGNAC

Élégant & Intemporel

MADE IN FRANCE

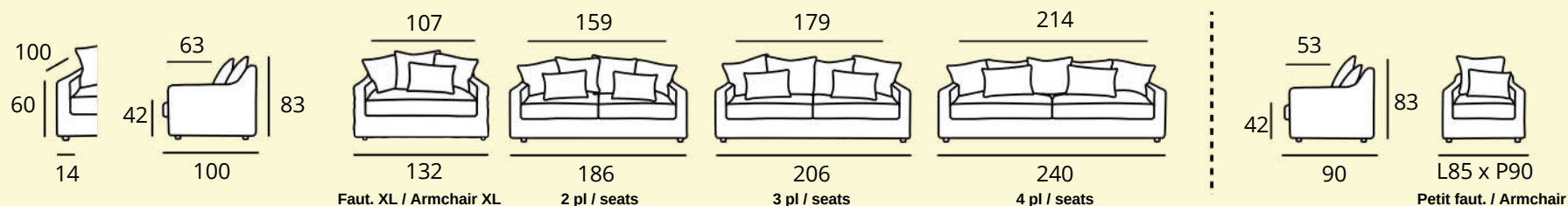

Structure : Hêtre, panneaux multiplex et panneaux de fibres. Structure enrobée de mousse polyuréthane et d'une sous-housse en foamé agrafée, suspension ressorts Nosags. **Assise :** Plumtex HR 35 kg/m³ + percale remplissage plumes. **Dossier :** Coussins 60 x 60 cm, remplissage plumes/flocons. **Coussins déco :** Coussins 60 x 45 cm, remplissage plumes/flocons. **Pieds :** Bois, teinté wengé. **Finition :** Tapissier.

Frame: Beech wood, multiplex and fiber panels. Frame wrapped in foam cover. Suspension no-sag springs. **Seat cushions:** Plumtex HR foam 35 kg/m³ + layer of feathers. **Back cushions:** cushions 60x60 cm, feathers/foam flake. **Deco cushions:** cushions 60x45 cm, feathers/foam flake. **Legs:** Wooden, wengé. **Finish:** Fixed covers.

Nb de coussins (cushions number) : Dos/Déco (back/deco) = Fauteuil : 1/1 - 2 pl : 4/2 - 3 pl : 4/2 - 4 pl : 5/2.



homespirit.fr

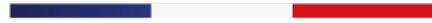

MADE IN FRANCE

BEAUSSET

Élégant & Intemporel



HOME SPIRIT

FRANCE

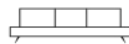

BEAUSSET

Élégant & Intemporel

MADE IN FRANCE

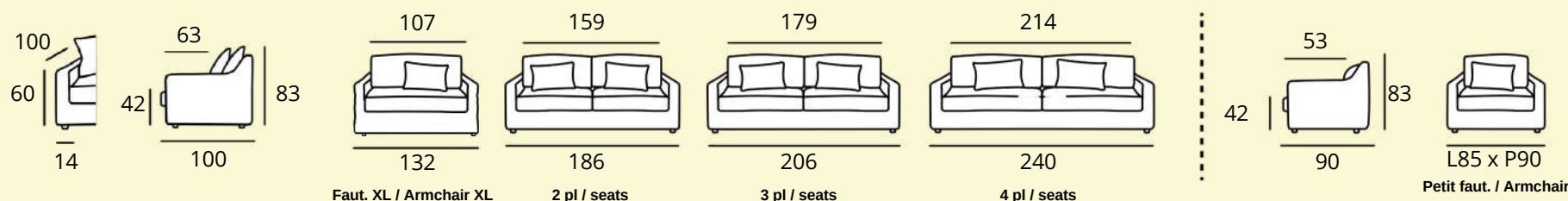

Structure : Hêtre, panneaux multiplex et panneaux de fibres. Structure enrobée de mousse polyuréthane et d'une sous-housse en foamé agrafée, suspension ressorts Nosags. **Assise :** Plumtex HR 35 kg/m³ + percale remplissage plumes. **Dossier :** coussins rectangulaires, remplissage plumes/flocons. **Coussins déco :** Coussins 60 x 45 cm, remplissage plumes/flocons. **Pieds :** Bois, teinté wengé. **Finition :** Tapissier.

Frame: Beech wood, multiplex and fiber panels. Frame wrapped in foam cover. Suspension no-sag springs. **Seat cushions:** Plumtex HR foam 35 kg/m³ + layer of feathers. **Back cushions:** rectangular cushions, feathers/foam flake. **Deco cushions:** cushions 60x45 cm, feathers/foam flake. **Legs:** Wooden, wengé. **Finish:** Fixed covers.

HOME SPIRIT

FRANCE



homespirit.fr



MADE IN FRANCE

CAP FERRET

& SAINT MARTIN

Élégance & Charme



HOME SPIRIT

FRANCE



CAP FERRET & SAINT MARTIN

Élégance & Charme

MADE IN FRANCE



* Option :

Point bourdon / Overcast stitch.

CAP FERRET Profondeur 90 cm

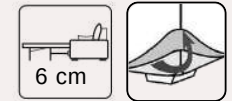
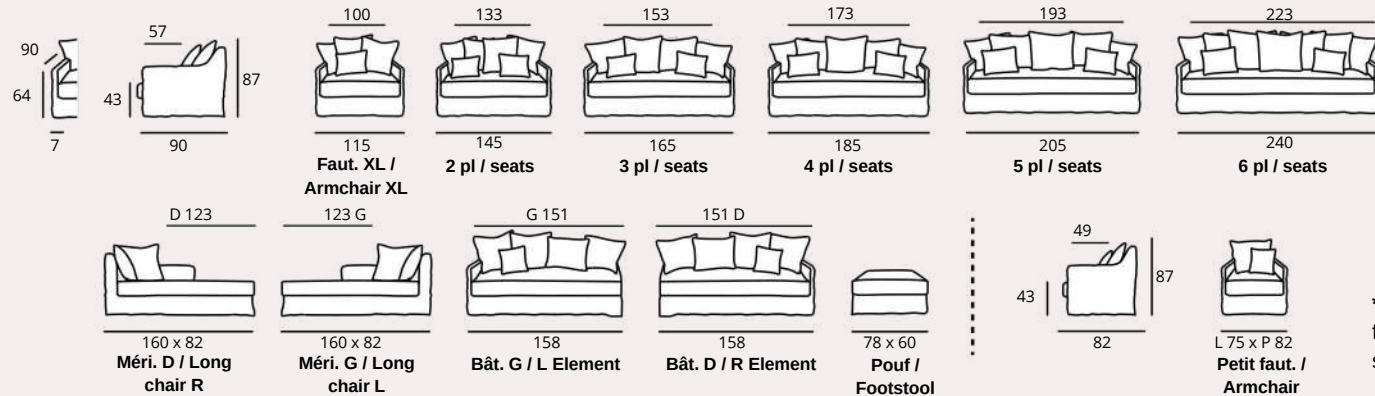

360°
* Option : petit
fauteuil pivotant /
swivel armchair

SAINT MARTIN Profondeur 100 cm

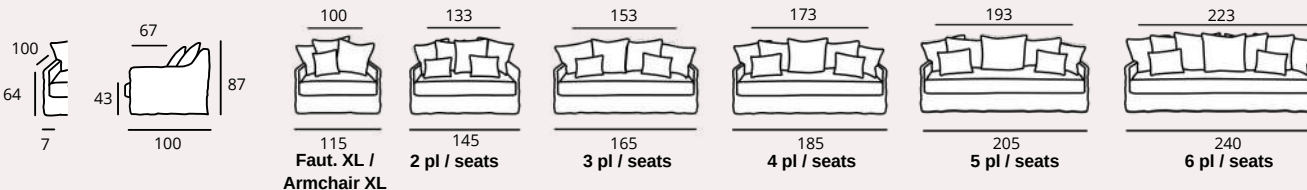

Structure : Hêtre, panneaux multiplex et panneaux de fibres. Structure enrobée de mousse polyuréthane et d'une sous-housse en foamé agrafée, suspension ressorts Nosags. **Assise :** Plumtex HR 35 kg/m³ + percale remplissage plumes. **Dossier :** Coussins 60 x 60 cm, remplissage plumes/flocons. **Coussins de déco :** Coussins 45 x 45 cm, remplissage en plumes/flocons. **Pieds :** Bois. **Couture :** bord à bord / pincé. **Finition :** déhoussable. *Option : Point bourdon - Convertible 6 cm - Petit fauteuil pivotant.

Frame: Beech wood, multiplex panels and fiber panels. Frame wrapped in foam cover. Suspension nosag springs. **Seat cushions:** Plumtex HR 35kg/m³ + layer of feathers. **Back cushions:** cushions 60x60cm, feathers/foam flakes. **Deco cushions:** cushions 45x45cm, feathers/foam flakes. **Legs:** Wooden. **Sewing:** Pinched sewing. **Finish:** Removable covers. *Option : Overcast stitch - Sofa bed 6 cm - Swivel armchair

Nb de coussins (cushions number) : Dos/Déco (back/deco) = Fauteuil : 1/1 - Faut. XL : 3/1 - 2 pl : 4/2 - 3 pl : 4/2 - 4 pl : 5/2 - 5 pl : 5/2 - 6 pl : 7/2 - Méridienne : 2/1 - Bâtard : 4/1.

HOME SPIRIT

FRANCE



homespirit.fr

MADE IN FRANCE

CASSIS

Convertible Grand Confort 14cm



HOME SPIRIT

FRANCE

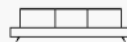

CASSIS

Convertible Grand Confort 14cm

MADE IN FRANCE

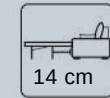
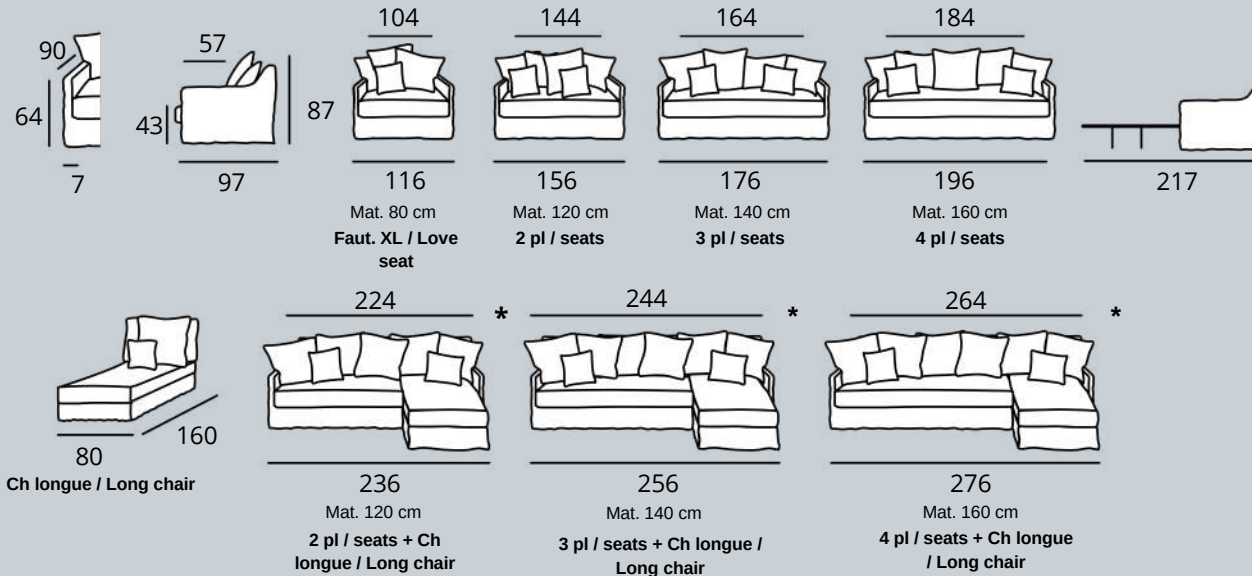

*Angle réversible, méridienne repositionnable à gauche ou à droite

Nb de coussins dossier (cushions number)

: Arrière/Avant/Déco (back/front/deco) = Faut

XL : 1/3/1 - 2 pl : 2/4/2 - 3 pl : 2/4/2 - 4 pl :

2/5/2 - Méridienne : 1/1/1.

Structure : Hêtre, panneaux multiplex et panneaux de fibres. Mécanique autoporteuse sommier grille et sangles entrecroisées en pieds ou mécanique autoporteuse Black Edition sommier latte (bi-zone pour 3 et 4 places) et sangles entrecroisées en pieds. **Assise** : Plumtex HR 35 kg/m³ + percale remplissage plumes. **Dossier** : **Arrière** : Deux grands coussins placés, mousse polyether 20 kg/m³. **Avant** : Coussins 60 x 60 cm, remplissage plumes/flocons. **Coussins de déco** : Coussins 45 x 45 cm, remplissage plumes/flocons. **Finition** : Déhoussable. **Matelas** : 14 cm Mousse HR Optimum 35 kg/m³. Dimensions : 80-120-140-160 x 200 cm. Assises et dossiers arrière restent en place à l'ouverture de la mécanique.

Frame : Solid beech wood, multiplex panels and fiber panels. **Selfsupporting bed mechanism** : Grid and elastic bands or selfsupporting bed mechanism Black Edition : slatted (bi-zone for 3 and 4 seats) and elastic bands. **Seat cushions**: Plumtex HR 35 kg/m³ + layer of feathers. **Back cushions**: **Back**: rectangular cushions, polyether foam 20 kg/m³. **Front**: 60x60cm filled with feathers/foam flakes. **Deco cushions**: 45x45cm with feathers/foam flakes. **Finish**: Removable covers. **Mattress**: 14 cm thick, HR foam Optimum 35 kg/m³. Dimensions 80-120-140-160 x 200 cm. No need to remove rectangular back cushions and seat cushions when folding and unfolding.

HOME SPIRIT

FRANCE



homespirit.fr



MADE IN FRANCE

CAP VERT & SAINT BARTH

Élégance & Charme



HOME SPIRIT

FRANCE



CAP VERT & SAINT BARTH

Élégance & Charme

MADE IN FRANCE



* Option :
Point bourdon / Overcast stitch.

CAP VERT

Profondeur 90 cm

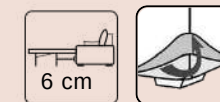
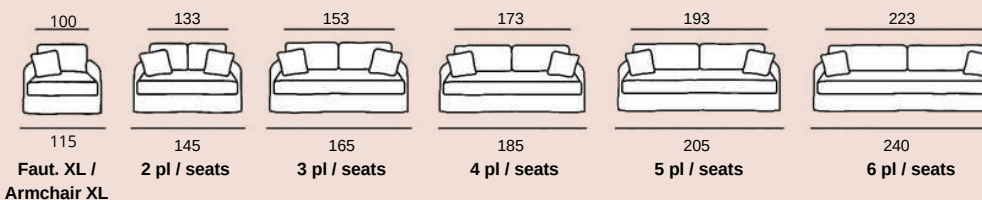
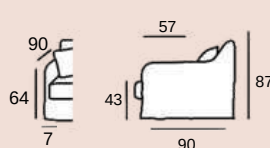

SAINT BARTH

Profondeur 100 cm

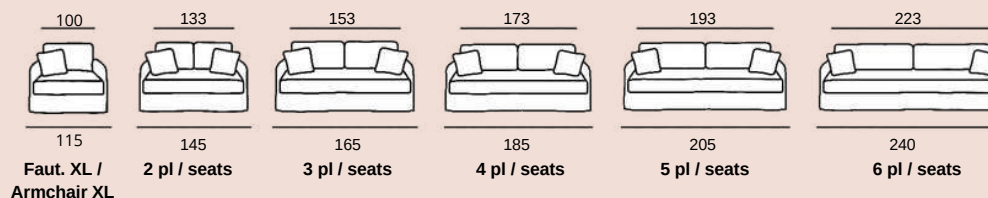
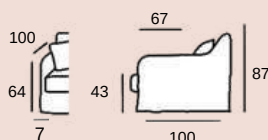

Structure : Hêtre, panneaux multiplex et panneaux de fibres. Structure enrobée de mousse polyuréthane et d'une sous-housse en foamé agrafée, suspension ressorts Nosags. **Assise :** Plumtex HR 35 kg/m³ + percale remplissage plumes. **Dossier :** 2 coussins de dos, remplissage plumes/flocons. **Coussins de déco :** Coussins 45 x 45 cm, remplissage en plumes/flocons. **Pieds :** Bois. **Couture :** bord à bord / pincé. **Finition :** déhoussable. ***Option :** Point bourdon - Convertible 6 cm.

Frame: Beech wood, multiplex panels and fiber panels. Frame wrapped in foam cover. Suspension nosags spings. **Seat cushions:** Plumtex HR 35kg/m³ + layer of feathers. **Back cushions:** 2 cushions, feathers/foam flake. **Deco cushions:** cushions 45x45cm, feathers/foam flakes. **Legs:** Wooden. **Sewing:** Pinched sewing. **Finish:** Removable covers. ***Option :** Overcast stitch - Sofa bed 6 cm.

HOME SPIRIT

FRANCE



homespirit.fr

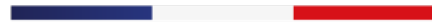

MADE IN FRANCE

CAP HORN

Convertible Grand Confort 14cm



HOME SPIRIT

FRANCE



CAP HORN

Convertible Grand Confort 14cm

MADE IN FRANCE

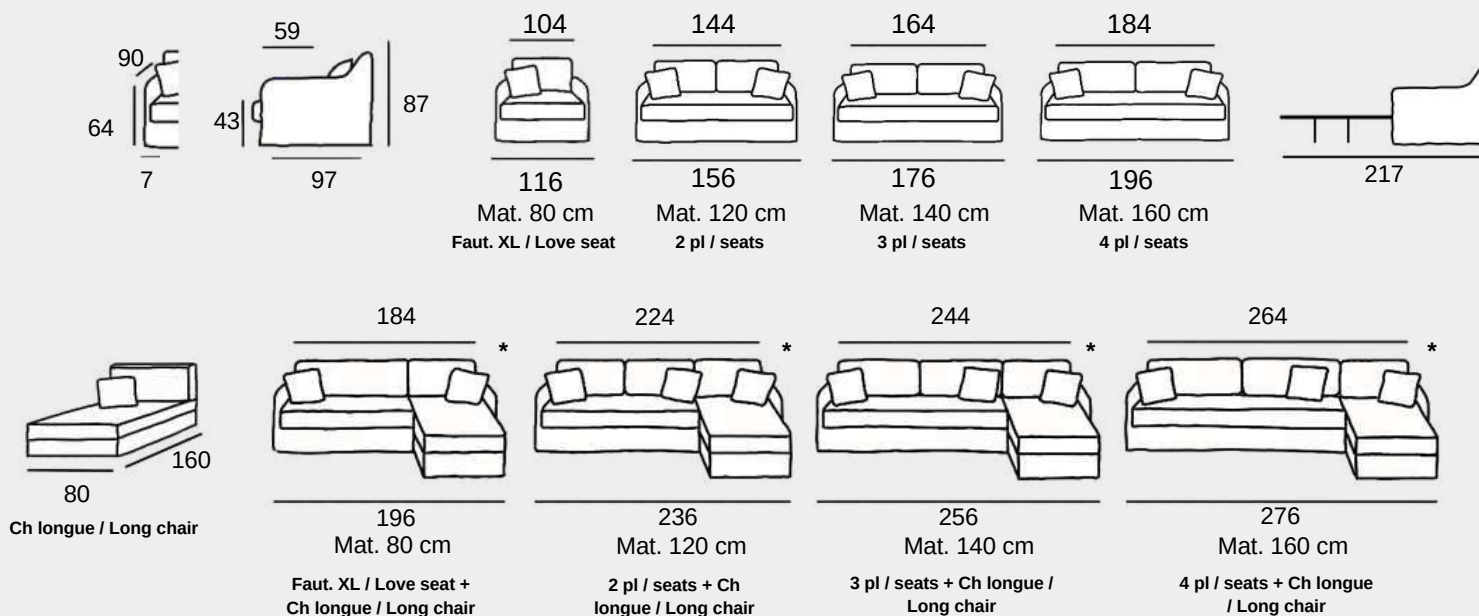

*Angle réversible à gauche ou à droite

*Corner réversible R/L

Structure : Hêtre, panneaux multiplex et panneaux de fibres. Mécanique autoporteuse sommier grille et sangles entrecroisées en pieds ou mécanique autoporteuse Black Edition sommier latte (bi-zone pour 3 et 4 places) et sangles entrecroisées en pieds. **Assise :** Plumtex HR 35 kg/m³ + percale remplissage plumes. **Dossier :** remplissage plumes/flocons. **Coussins de déco :** Coussins 45 x 45 cm, remplissage plumes/flocons. **Finition** Déhoussable. **Pieds :** Bois. **Matelas :** 14 cm Mousse HR Optimum 35 kg/ m³. Dimensions : 80-120-140-160 x 200 cm. Assises et dossiers restent en place à l'ouverture de la mécanique.

Frame: Solid beech wood, multiplex panels and fiber panels. **Selfsupporting bed mechanism :** Grid and elastic bands or selfsupporting bed mechanism Black Edition : slatted (bi-zone for 3 and 4 seats) and elastic bands. **Seat cushions:** Plumtex HR 35 kg/m³ + layer of feathers. **Back cushions:** filled with feathers/foam flakes. **Deco cushions:** cushions 45 x 45 cm, feathers/foam flakes. **Finish:** Removable covers. **Legs:** Wooden. **Mattress:** 14 cm thick, HR foam Optimum 35 kg/m³. Dimensions 80-120-140-160 x 200 cm. No need to remove back and seat cushions when folding and unfolding.

HOME SPIRIT

FRANCE



homespirit.fr

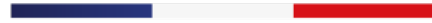

MADE IN FRANCE

CHAMONIX

& CHAMBORD

Actuel & Moelleux



HOME SPIRIT

FRANCE

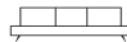

CHAMONIX & CHAMBORD

Actuel & Moelleux

MADE IN FRANCE

CHAMONIX

Profondeur 110 cm

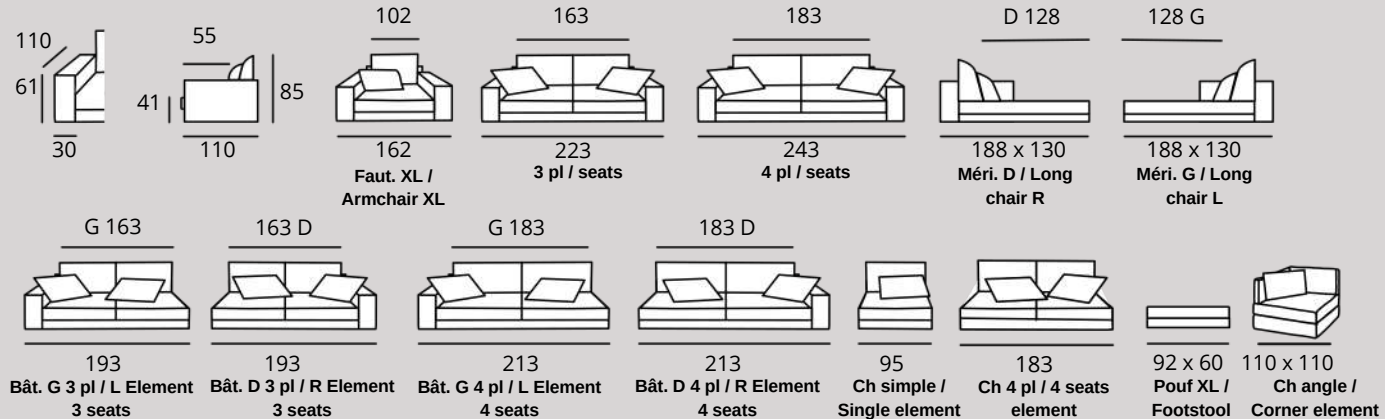

CHAMBORD

Profondeur 100 cm

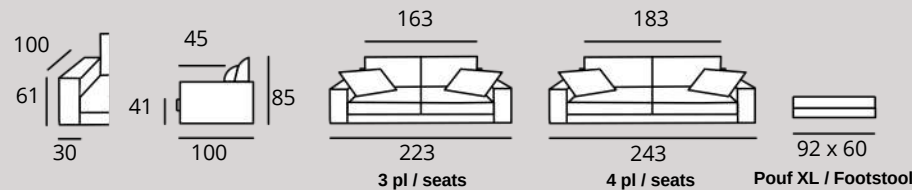

Structure : Hêtre, panneaux multiplex et panneaux de fibres. Structure enrobée de mousse polyuréthane. Manchette enrobée de ouate 650g et surmontée d'une percale en plumes, suspension ressorts Nosags. **Assise :** Plumtex mousse HR 35 kg/m³ + percale de plumes. **Dossier :** **Arrière :** Coussins rectangulaires, remplissage plumes/flocons. **Avant :** Coussins remplissage plumes/flocons. **Coussins déco :** 2 coussins, remplissage plumes/flocons. **Pieds :** Bois. **Finition :** Tapissier.

Frame: Beech wood, multiplex and fiber panels. Frame wrapped in foam cover. Arm covered with a 650 g cotton-wool & double layered with a percale cover with feathers. Suspension nosags springs. **Seat cushions:** Plumtex HR foam 35 kg/m³ + layer of feathers. **Back cushions:** **Back:** Rectangular cushions, feathers/foam flakes. **Front:** cushions filled with feathers/foam flakes. **Deco cushions:** 2 cushions filled with feathers/foam flakes. **Legs:** Wooden. **Finish:** Fixed covers.

HOME SPIRIT

FRANCE



homespirit.fr

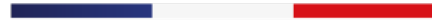

MADE IN FRANCE

COLOGNE

Actuel & Moelleux



HOME SPIRIT

FRANCE



COLOGNE

Actuel & Moelleux

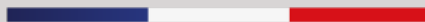

MADE IN FRANCE

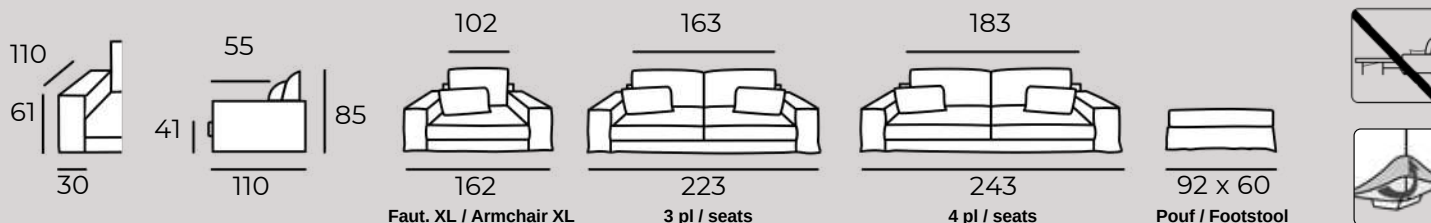

Structure : Hêtre, panneaux multiplex et panneaux de fibres. Structure enrobée de mousse polyuréthane. Manchette enrobée de ouate 650g et surmontée d'une percale en plumes, suspension ressorts Nosags. **Assise :** Plumtex mousse HR 35 kg/m³ + percale de plumes. **Dossier : Arrière :** Coussins rectangulaires, remplissage plumes/flocons - **Avant :** Remplissage plumes/flocons. **Coussins déco :** 2 coussins remplissage plumes/flocons. **Pieds :** Bois. **Finition :** Déhoussable.

Frame: Beech wood, multiplex and fiber panels. Frame wrapped in foam cover. Arm covered with a 650 g cotton-wool & double layed with a percale cover with feathers. Suspension nosag springs. **Seat cushions:** Plumtex HR foam 35 kg/m³ + layer of feathers - **Back cushions: Back:** Rectangular cushion, feathers/foam flakes - **Front:** cushions filled with feathers/foam flakes - **Deco cushions:** 2 cushions filled with feathers/foam flakes. **Legs:** Wooden. **Finish:** Removable covers.

HOME SPIRIT

FRANCE



homespirit.fr

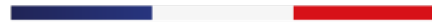

MADE IN FRANCE

CHARLES

Convertible Grand Confort 14cm



HOME SPIRIT

FRANCE



CHARLES

Convertible Grand Confort 14cm

MADE IN FRANCE

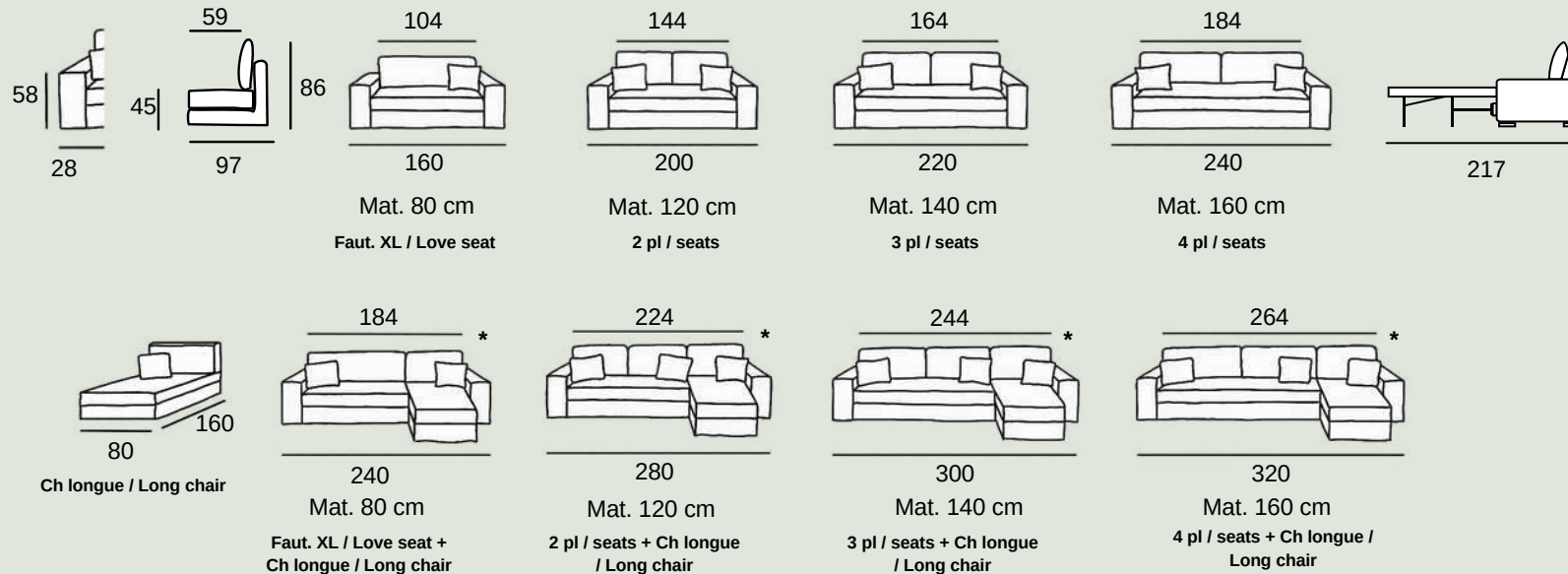

*Angle réversible à gauche ou à droite

*Corner réversible R/L

Structure : Hêtre, panneaux multiplex et panneaux de fibres. Mécanique autoporteuse sommier grille et sangles entrecroisées en pieds ou mécanique autoporteuse Black Edition sommier latte (bi-zone pour 3 et 4 places) et sangles entrecroisées en pieds. **Assise :** Plumtex HR 35 kg/m³ + percale remplissage plumes. **Dossier :** remplissage plumes/flocons. **Coussins de déco :** Coussins 40 x 60 cm, remplissage plumes/flocons. **Finition** Déhoussable. **Pieds :** Bois. **Matelas :** 14 cm Mousse HR Optimum 35 kg/ m³. Dimensions : 80-120-140-160 x 200 cm. Assises et dossiers restent en place à l'ouverture de la mécanique.

Frame: Solid beech wood, multiplex panels and fiber panels. **Selfsupporting bed mechanism :** Grid and elastic bands or selfsupporting bed mechanism Black Edition : slatted (bi-zone for 3 and 4 seats) and elastic bands. **Seat cushions:** Plumtex HR 35 kg/m³ + layer of feathers. **Back cushions:** filled with feathers/foam flakes. **Deco cushions:** cushions 40 x 60 cm, feathers/foam flakes. **Finish:** Removable covers. **Legs:** Wooden. **Mattress:** 14 cm thick, HR foam Optimum 35 kg/m³. Dimensions 80-120-140-160 x 200 cm. No need to remove back and seat cushions when folding and unfolding.

HOME SPIRIT

FRANCE



homespirit.fr

MADE IN FRANCE

FARO

Élégant & Audacieux



HOME SPIRIT

FRANCE

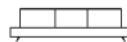

FARO

Élégant & Audacieux

MADE IN FRANCE

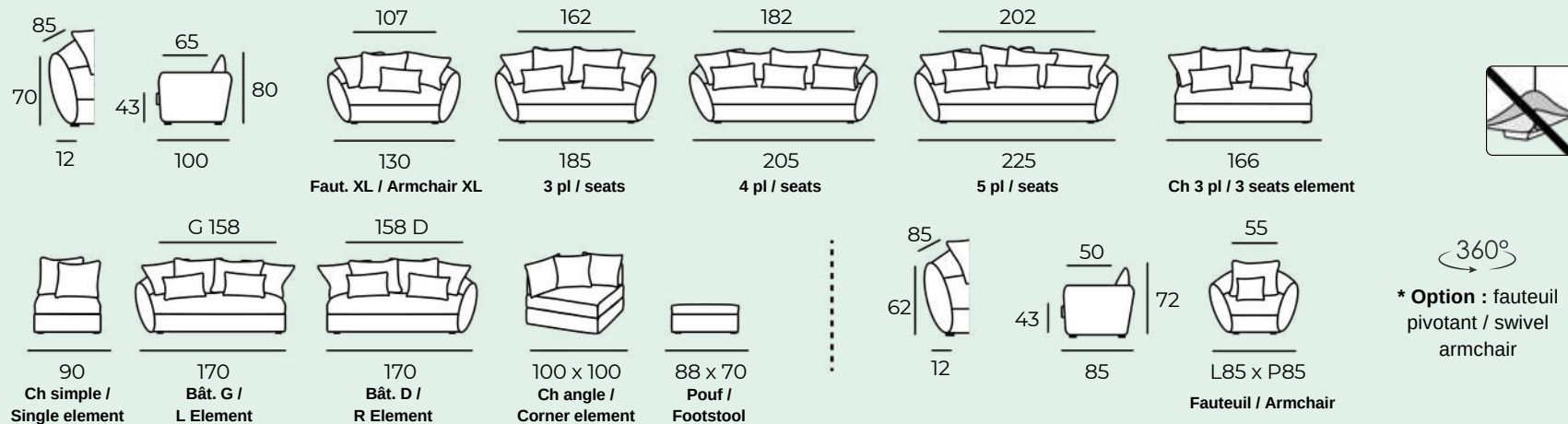

Structure : Hêtre, panneaux multiplex et panneaux de fibres. Structure enrobée de mousse polyuréthane et de ouate 650 g, suspension ressorts Nosags. **Assise :** Plumtex HR 35 kg/m³ + percale remplissage plumes. **Dossier :** Coussins 60 x 60 cm, remplissage plumes/flocons. **Coussins déco :** Coussin 45 x 60 cm, remplissage plumes/flocons. **Pieds :** Bois. **Finition :** Tapissier. ***Option :** Fauteuil pivotant.

Frame: Solid beech wood, multiplex panels and fiber panels. Frame wrapped in foam cover and double layered with a fiber cover. Suspension Nosags springs. **Seat cushions:** Plumtex HR 35 kg/m³ + layer of feathers. **Back cushions:** Cushions 60x60cm, feathers/foam flakes. **Deco cushions:** Cushions 45x60cm, feathers/foam flakes. **Legs:** Wooden. **Finish:** Fixed covers. ***Option :** Swivel armchair

Nb de coussins (cushions number) : Dos/Déco (back/deco) = Fauteuil : 1/1 - Fauteuil XL : 3/1 - 4 places : 4/3 - 5 places : 5/3 - Bâtard 3 places : 4/2 - Chauffeuse simple : 2/0 - Chauffeuse 3 places : 4/2 - Chauffeuse d'angle : 3/0 - Pouf : 0/0.

HOME SPIRIT

FRANCE



homespirit.fr

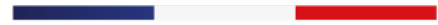

MADE IN FRANCE

FIGARI

Élégant & Audacieux



HOME SPIRIT

FRANCE

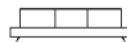

FIGARI

Élégant & Audacieux

MADE IN FRANCE

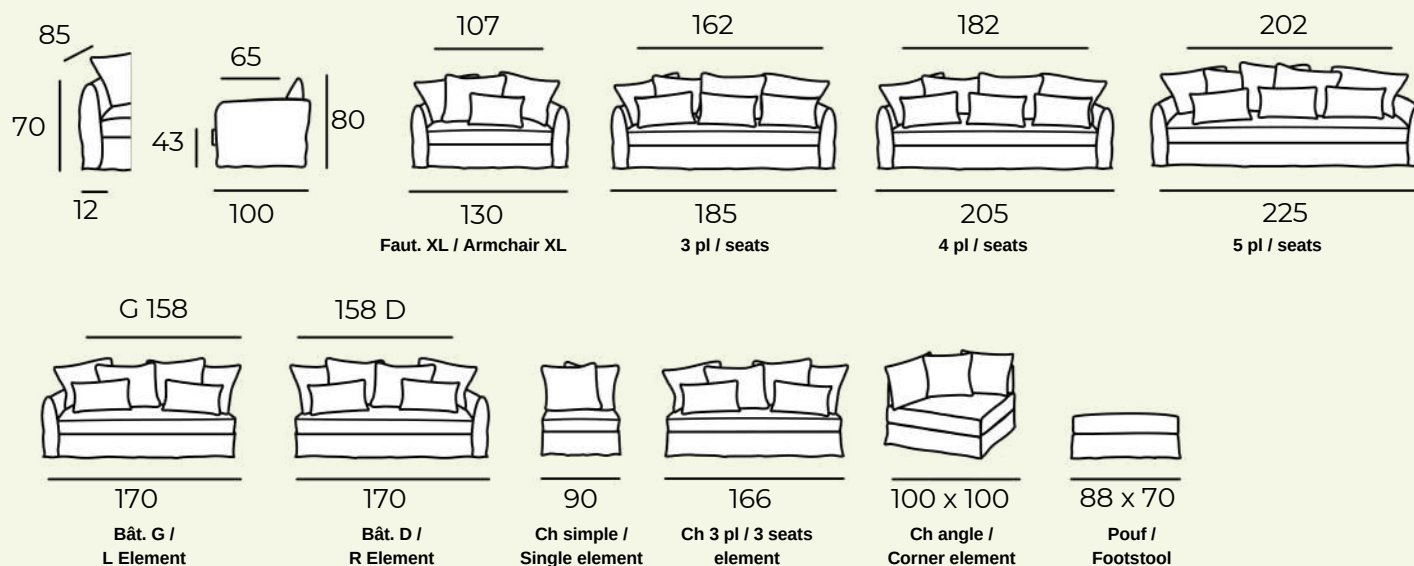

Structure : Hêtre, panneaux multiplex et panneaux de fibres. Structure enrobée de mousse polyuréthane et de ouate 650 g, suspension ressorts Nosags. **Assise :** Plumtex HR 35 kg/m³ + percale remplissage plumes. **Dossier :** Coussins 60 x 60 cm, remplissage plumes/flocons. **Coussins déco :** Coussin 45 x 60 cm, remplissage plumes/flocons. **Pieds :** Bois. **Finition :** 100% déhoussable.

Frame: Solid beech wood, multiplex panels and fiber panels. Frame wrapped in foam cover and double layered with a fiber cover. Suspension Nosag springs. **Seat cushions:** Plumtex HR 35 kg/m³ + layer of feathers. **Back cushions:** Cushions 60x60cm, feathers/foam flakes. **Deco cushions:** Cushions 45x60cm, feathers/foam flakes. **Legs:** Wooden. **Finish:** Removable covers.

Nb de coussins (cushions number) : Dos/Déco (back/deco) = Fauteuil XL : 3/1 - 3 places : 4/3 - 4 places : 4/3 - 5 places : 5/3 - Bâtard 3 places : 4/2 - Chauffeuse simple : 2/0 - Chauffeuse 3 places : 4/2 - Chauffeuse d'angle : 3/0 - Pouf : 0/0 - Fauteuil XL+Pouf : 3/1.

HOME SPIRIT

FRANCE



homespirit.fr

MADE IN FRANCE

FIGEAC

Chic & Généreux



HOME SPIRIT

FRANCE

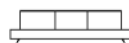

FIGEAC

Chic & Généreux

MADE IN FRANCE

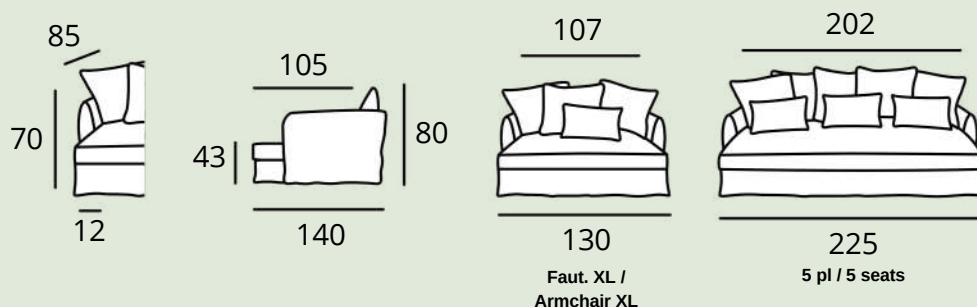

Structure : Hêtre, panneaux multiplex et panneaux de fibres. Structure enrobée de mousse polyuréthane et de ouate 650 g, suspension ressorts Nosags. **Assise** : Plumtex HR 35 kg/m³ + percale remplissage plumes. **Dossier** : Coussins 60 x 60 cm, remplissage plumes/flocons. **Coussins déco** : Coussin 45 x 60 cm, remplissage plumes/flocons. **Pieds** : Bois. **Finition** : 100% déhoussable.

Frame: Solid beech wood, multiplex panels and fiber panels. Frame wrapped in foam cover and double layered with a fiber cover. Suspension No-sags springs. **Seat cushions**: Plumtex HR 35 kg/m³ + layer of feathers. **Back cushions**: Cushions 60x60cm, feathers/foam flakes. **Deco cushions**: Cushions 45x60cm, feathers/foam flakes. **Legs**: Wooden. **Finish**: Removable covers.

Nb de coussins (cushions number) : Dos/Déco (back/deco) = Fauteuil XL : 3/1 - 5 places : 5/3.

Modèle composé d'un canapé et d'un élément type pouf, à fixer à l'aide de pinces crocodiles.

Sofa with two elements, to assemble with crocodile clips.



homespirit.fr

MADE IN FRANCE

NOMAD

Confortable & Généreux



HOME SPIRIT

FRANCE

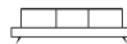

NOMAD

Confortable & Généreux

MADE IN FRANCE

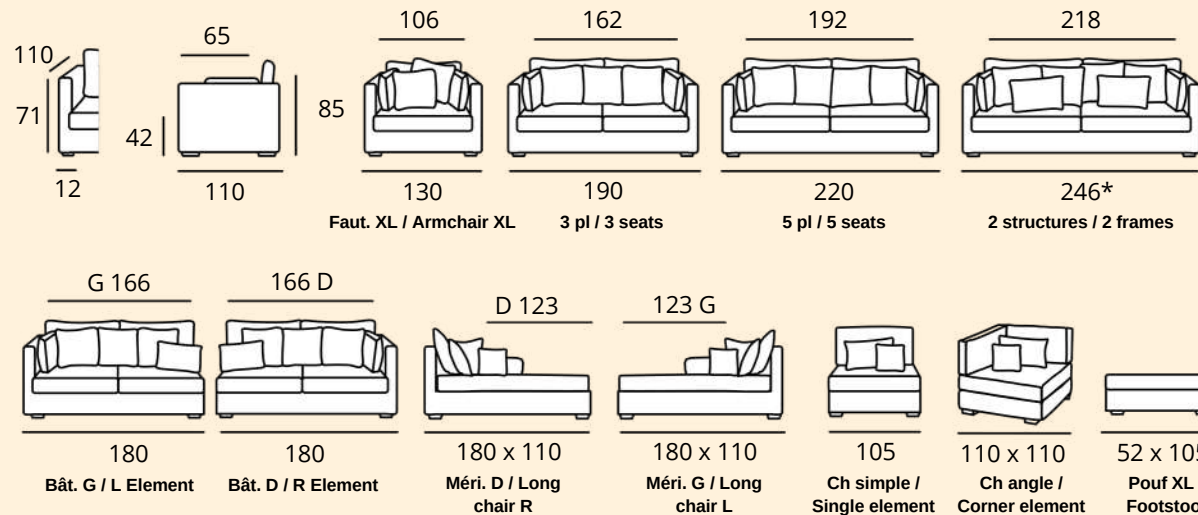

Structure : Hêtre, panneaux multiplex et panneaux de fibres. Structure enrobée de mousse polyuréthane et d'une sous-housse en foamé agrafée, suspension ressorts Nosags. **Assise :** Plumtex HR 35 kg/m³ + percale remplissage plumes. **Dossier :** **Arrière :** Coussins rectangulaires, remplissage plumes/flocons - **Avant :** Coussins 45 x 45 cm, remplissage plumes/flocons. **Coussins accoudoirs :** Coussin 60 x 40 cm, remplissage plumes/flocons. **Pieds :** Bois. **Finition :** Déhoussable. * La caisse du canapé 246 cm est livrée en 2 pièces : 2 structures de bâtard de 123 cm avec une housse unique de 246 cm.

Frame: Beech wood, multiplex and fiber panels. Frame wrapped in foam cover. Suspension Nosags springs. **Seat cushions:** Plumtex HR foam 35 kg/m³ + layer of feathers. **Back cushions: Back:** Rectangular cushions, feathers/foam flakes - **Front:** Cushion 45x45 cm, filled with feathers/foam flakes. **Arm cushion:** Cushion 60x40cm, filled with feathers/foam flakes. **Legs:** Solid wooden. **Finish:** Removable covers. * Sofa 246 cm is made of 2 frames : with one unique fabric cover on the structure.

Nb de coussins dossier (cushions number) : Arrière/Avant/Accoudoirs (back/front/arm) = Faut XL : 1/2/2 - 3 pl : 2/3/2 - 5 pl : 2/4/2 - 6 pl : 2/4/4 - Bâtard : 2/3/2 - Méridienne : 1/2/1 - Ch simple : 1/1/1 - Ch angle : 2/1/1.

HOME SPIRIT

FRANCE



homespirit.fr

MADE IN FRANCE

TACOMA

Compact & Réversible



HOME SPIRIT

FRANCE

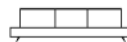

TACOMA

Compact & Réversible

MADE IN FRANCE

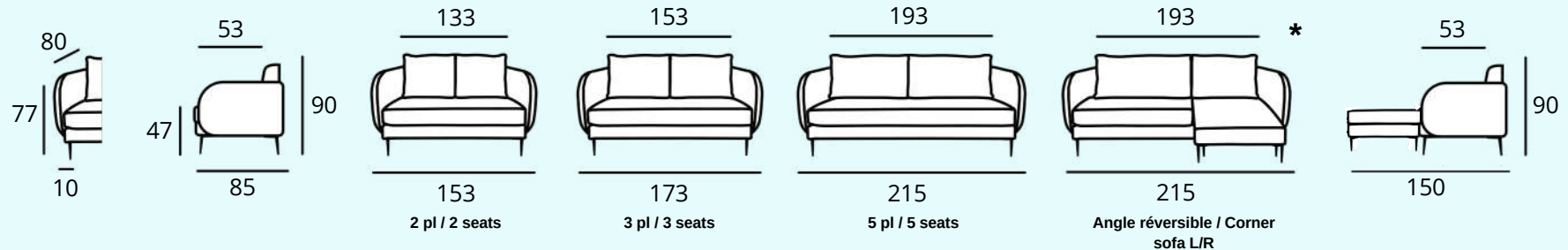

Structure : Bois massif, panneaux de fibres et panneaux de particules. Suspension d'assise ressorts Nosags. **Assise :** Mousse HR 35 kg/m³ + HR 26 kg/m³ - Coussin mono-assise pour 2 pl, 3 pl et 5 pl - Deux assises pour l'angle. **Dossier :** Coussins rectangulaires, remplissage fibres creuses siliconées. **Pieds :** Métal - noir - hauteur 17 cm. **Couture :** Sellier. **Finition :** Tapissier.

Frame: Solid beech wood, fiber panels and multiplex panels. Suspension Nosags springs. **Seat cushions:** HR foam 35 kg/m³ + HR 26 kg/m³. Only one cushion for 2 seats, 3 seats and 5 seats - Two cushions for corner sofa. **Back cushions:** Fibers. **Legs:** Metal - black - height 17 cm. **Sewing:** Double stitching. **Finish:** Fixed covers.

* Canapé d'angle réversible composé d'un canapé et d'un pouf : pouf, assises et dossiers repositionnables à gauche ou à droite.
 Reversible corner sofa including sofa + footstool : footstool, seats and back cushions can be set on the left or on the right.

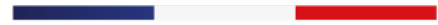

MADE IN FRANCE

PETER

Urbain & Raffiné

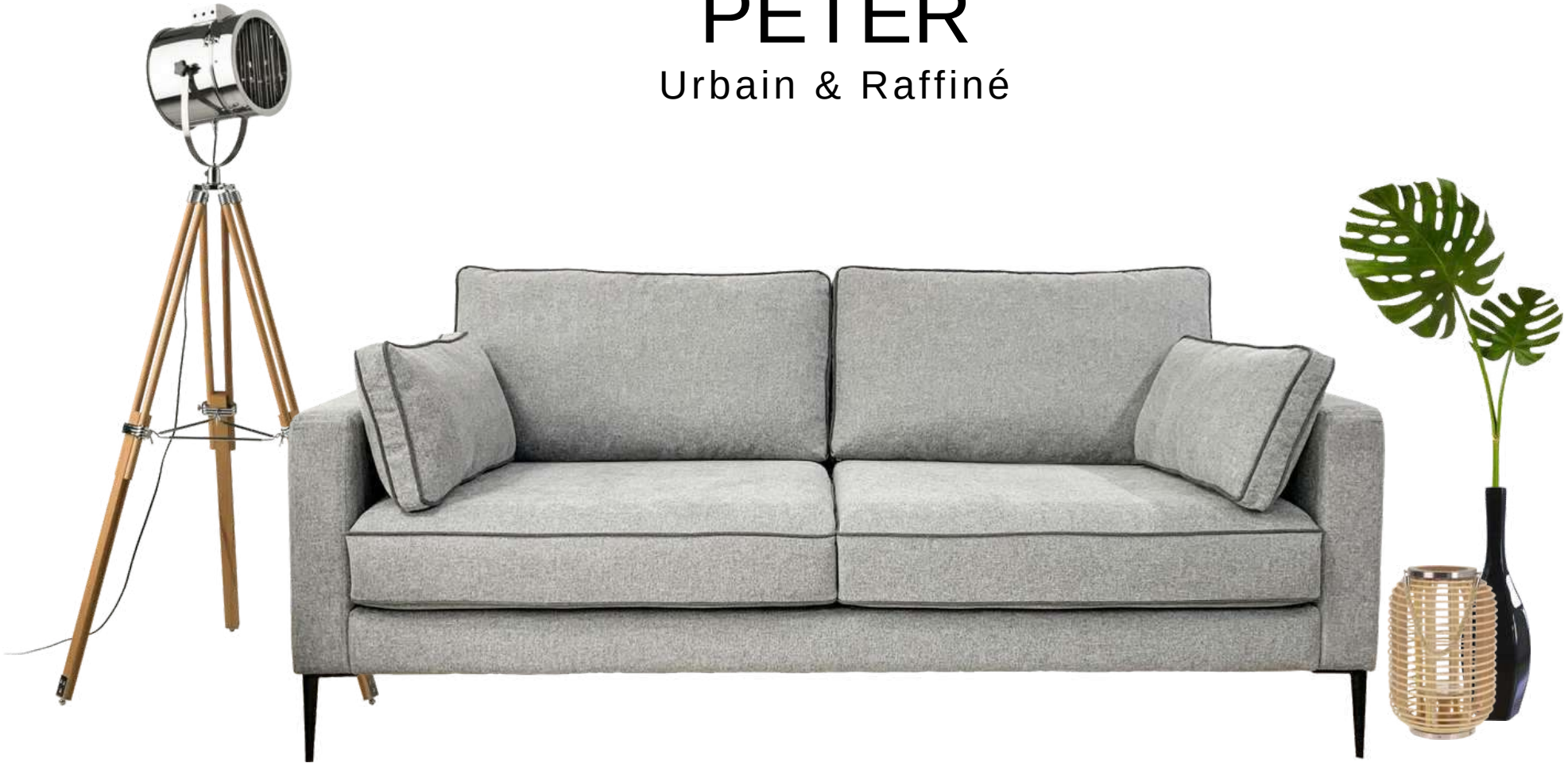

HOME SPIRIT

FRANCE

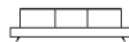

PETER

Urbain & Raffiné

MADE IN FRANCE

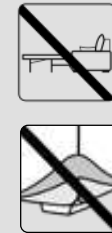
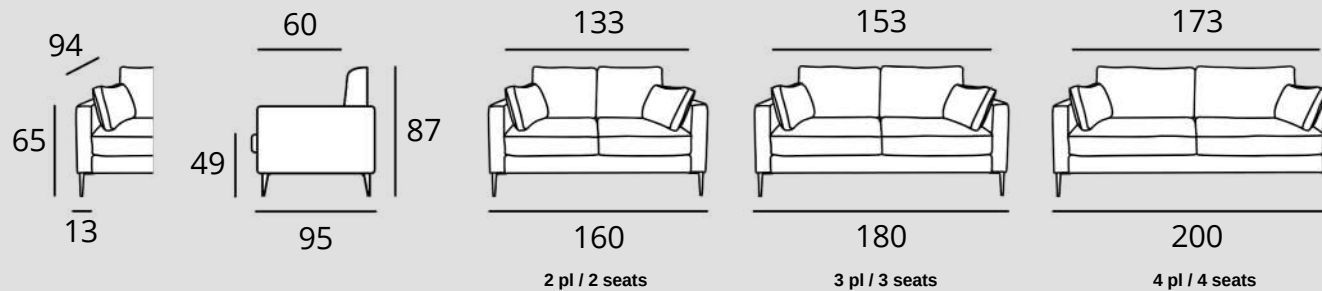

Structure : Bois massif, panneaux de fibres et panneaux de particules. **Assise :** Mousse HR 35 kg/m³ + HR 26 kg/m³. **Dossier :** Coussins rectangulaires, remplissage fibres creuses siliconées. **Coussins déco :** 2 x coussins 60 x 30 cm, remplissage fibres. **Pieds :** Métal - noir - hauteur 17 cm. **Couture :** Surpiqûre plate sur la structure. Passepoil sur les coussins d'assise, de dos et de déco. **Finition :** Tapissier.

Frame: Solid beech wood, fiber panels and multiplex panels. **Seat cushions:** HR foam 35 kg/m³ + HR 26 kg/m³. **Back cushions:** Fibers. **Deco cushion:** 60x30cm fibers. **Legs:** Metal - black - height 17 cm. **Sewing:** Flat topstitch on the frame. Piping on seat, back and deco cushions. **Finish:** Fixed covers.



homespirit.fr

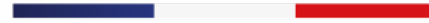

MADE IN FRANCE

SPENCER

Intemporel & Compact



HOME SPIRIT

FRANCE

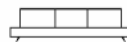

SPENCER

Intemporel & Compact

MADE IN FRANCE

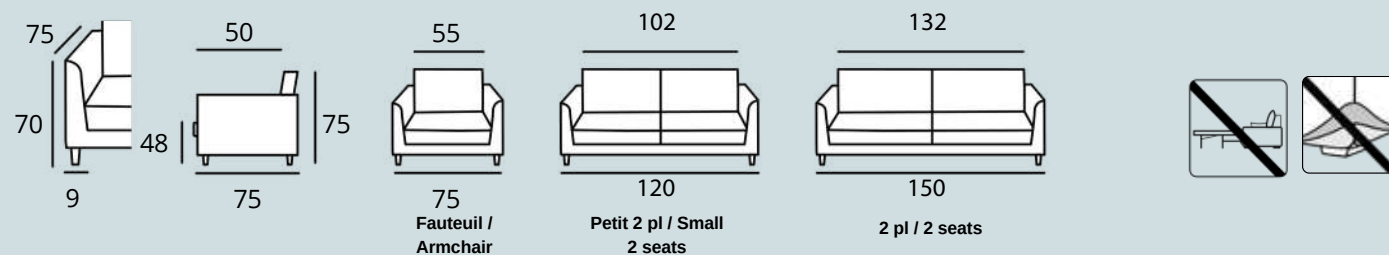

Structure : Hêtre, panneaux multiplex et panneaux de fibres. Structure enrobée de mousse polyuréthane et d'une sous-housse en foamé agrafée, suspension sangles. **Assise :** Mousse HR 35 kg/m³ + HR 23 kg/m³. **Dossier :** Remplissage fibres creuses siliconées. **Pieds :** Métal noir. **Finition :** Tapissier.

Frame: Beech wood, multiplex and fiber panels. Frame wrapped in foam cover. Suspension elastic bands. **Seat cushions:** HR foam 35 kg/m³ + HR foam 23 kg/m³. **Back cushions:** fibers. **Legs :** Black metal. **Finish:** Fixed covers.

HOME SPIRIT

FRANCE



homespirit.fr

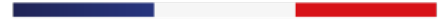

MADE IN FRANCE

VANG

Contemporain & Épuré



HOME SPIRIT

FRANCE

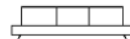

VANG

Contemporain & Épuré

MADE IN FRANCE

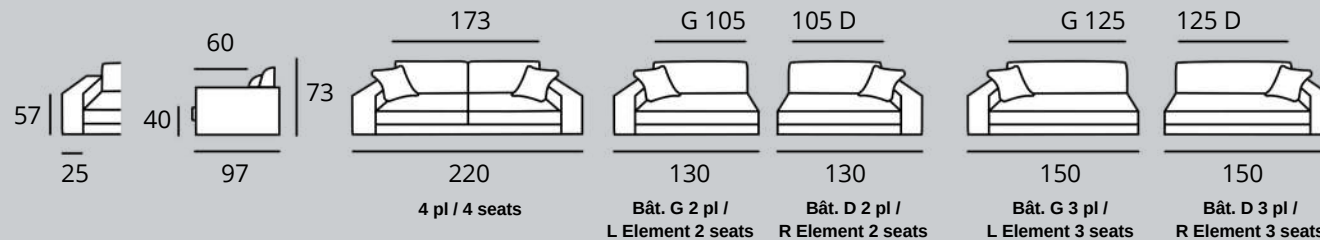

Structure : Hêtre, panneaux multiplex et panneaux de fibres. Structure enrobée de mousse polyuréthane et d'une housse en foamé aggrafée. Suspension ressorts Nosags. **Assise** : Mousse HR 35 kg/m³ + HR 25 kg/m³. **Dossier** : Coussins rectangulaires, fibres creuses siliconées. **Coussins déco** : Remplissage plumes/flocons. **Pieds** : Bois. **Finition** : Tapissier.

Frame: Beech wood, multiplex panels and fiber panels. Frame wrapped in polyurethane foam with a white foam cover. Suspension Nosag springs. **Seat cushions**: HR 35 kg/m³ + HR 25 kg/m³. **Back cushions**: Rectangular cushions, filled with fibers. **Deco cushions**: Filled with feathers/foam flakes. **Legs**: Wooden. **Finish**: Fixed covers.

HOME SPIRIT

FRANCE



homespirit.fr

MADE IN FRANCE

POUF, DOMINO & TÊTIÈRE

Personnalisés & Pétillants



HOME SPIRIT

FRANCE

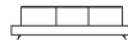

POUF, DOMINO & TÊTIÈRE

Personnalisés & Pétillants



MADE IN FRANCE

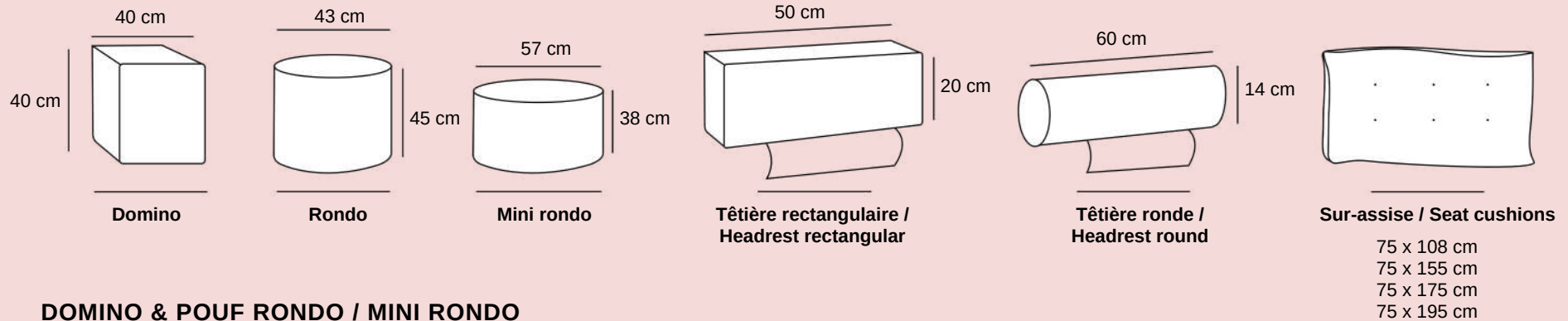

DOMINO & POUF RONDO / MINI RONDO

Structure : Hêtre. Panneaux multiplex. Structure enrobée de mousse polyuréthane. **Finition :** Tapissier.

Frame: Beech wood. Multiplex panels. Frame wrapped in foam cover. **Finish:** Fixed covers.

TÊTIÈRE RECTANGULAIRE OU RONDE / HEADREST

Structure : Mousse 17 kg/m³, support métal. **Finition :** Déhoussable

Frame: Foam 17 kg/m³, metal support. **Finish:** Removable covers.

SUR-ASSISE / SEAT CUSHIONS

Structure : Remplissage fibre. **Finition :** Passepoil.

Frame: Filled with fibers, **Finish:** Stitching in piping.



homespirit.fr



MADE IN FRANCE

GAMME COUSSINS

HOME SPIRIT

FRANCE

GAMME COUSSINS



MADE IN FRANCE



45 x 45

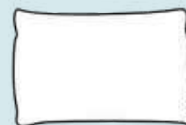

30 x 50



40 x 60

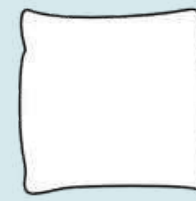

60 x 60

Voir l'ensemble de l'offre sur le tarif.
See the whole range of cushions on the price list.

HOME SPIRIT



homespirit.fr

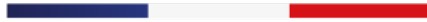

MADE IN FRANCE

Retrouvez nous sur www.homespirit.fr

